

IGUANA
LASER SERIES

(\emptyset 1,57 \pm 0,02)

außergewöhnlich.

SHARP.



Z ZECHA

Einzelheit A

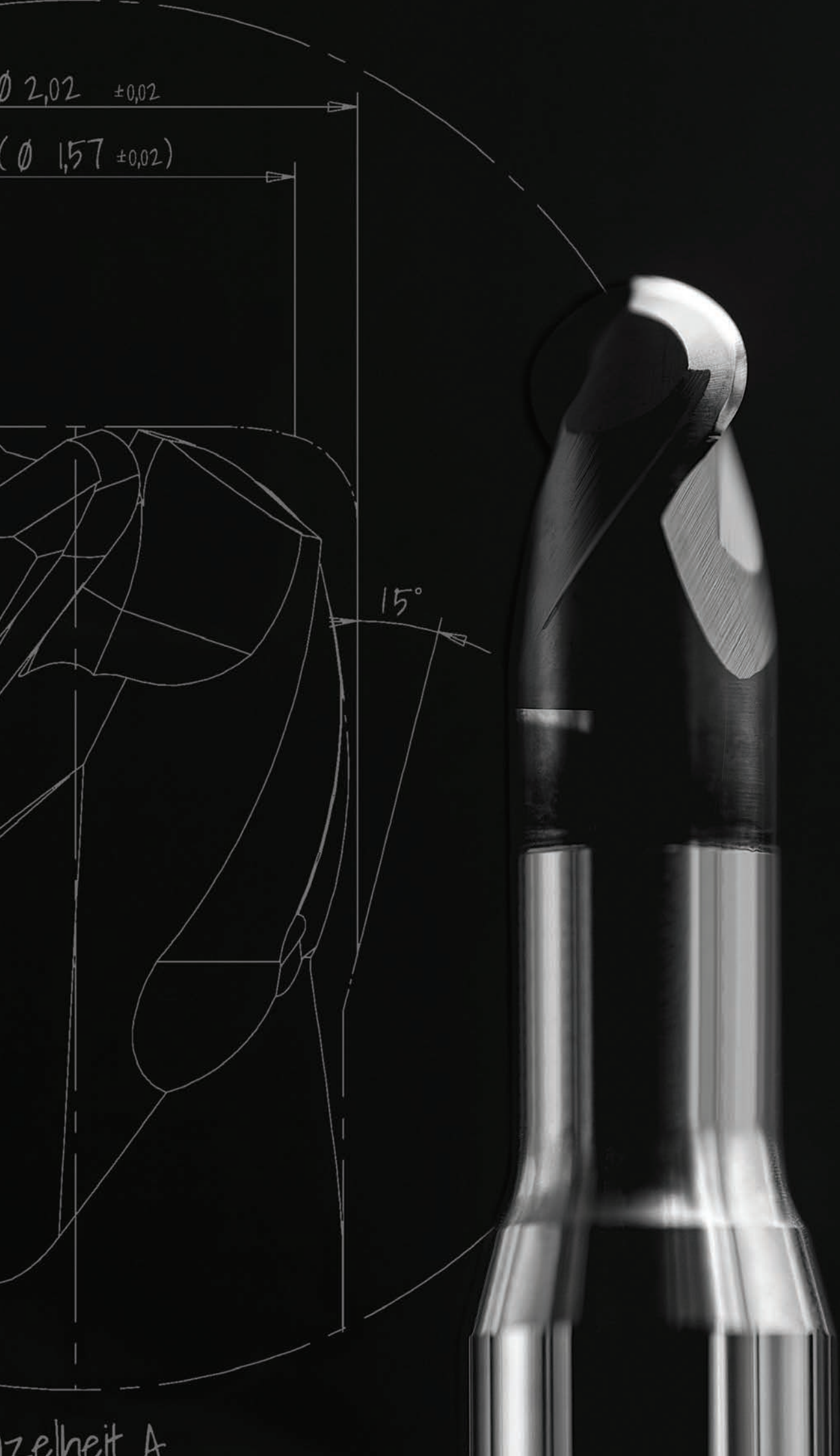

ZECHA
außergewöhnlich.

IGUANA
LASER SERIES

(\varnothing 1,57 \pm 0,02)

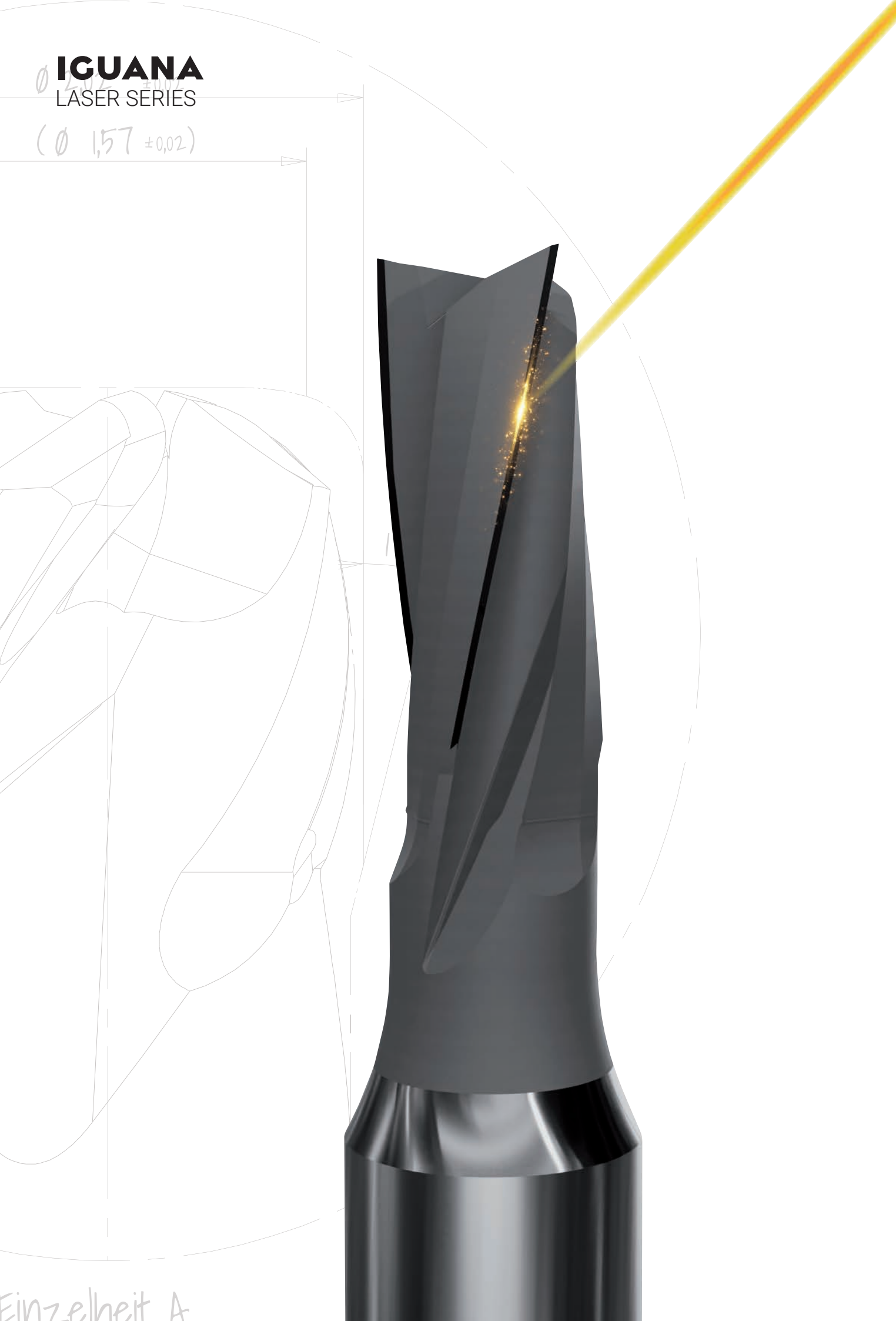

IGUANA LASER SERIES

LASER-SHARP AND EXACTLY PRECISE

Introducing the IGUANA LASER SERIES tools by ZECHA – a groundbreaking leap forward in precision milling technology. Setting a new standard in machining excellence, the IGUANA LASER SERIES redefines the lifetimes of end mills and drills with its world-first innovation: laser-processing of diamond coatings.

The IGUANA technology, built for cutting non-ferrous metals, eliminates the age-old challenge of rounded cutting edges on coated tools, which, until now, has limited machining processes and causes higher cutting forces.

The IGUANA LASER SERIES ushers in a new era of sharpness, reliability, and longevity. The revolutionary laser-processing of diamond coatings ensures that each cutting edge boasts a flawlessly sharp profile. This transformative feature drastically extends the tools' lifespan, delivering

unmatched durability that stands the test of time. Machining professionals will experience a quantum leap in performance as the IGUANA LASER SERIES enhances surface finishes and consistently precise end products.

The precise cutting edges achieved through this innovation translate into superior surface finishes, reducing the need for secondary operations and saving valuable time and resources.

With the IGUANA LASER SERIES, gone are the days of frequent tool replacements and compromised outcomes. The tools' ability to maintain their extremely sharp edges over an extended period guarantees consistent, reliable results that endure far beyond conventional expectations.

IGUANA
LASER SERIES

(\emptyset 1,57 \pm 0,02)



LASER-SHARPENED DIAMOND COATING

PERFECTLY SHARP COATED EDGES

The groundbreaking technology showcased in the IGUANA LASER SERIES end mills and drills by ZECHA is the culmination of over a decade of relentless dedication to research, testing, and development.

The pivotal breakthrough came through the final combination of new laser technology and a specially-developed diamond coating, sharpened on one side or both, resulting in coated-edges that are perfectly homogenous, flawlessly sharp (radius of up to 1 μ m) and uniquely strong.

The fusion of laser technology and a perfected diamond coating has revolutionized the performance of the IGUANA LASER SERIES. This innovative pairing significantly reduces cutting forces, thereby minimizing heat generation during the machining process. The outcome is two-fold: improved surface finishes that meet the highest standards of excellence and an extended lifespan that sets an industry benchmark.

The IGUANA LASER SERIES not only embodies the peak of precision and craftsmanship but also paves the way for a future where machining achieves new heights of efficiency, quality, and durability.

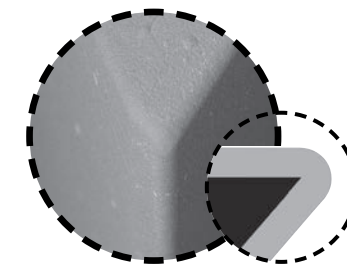

Normal Diamond Coating

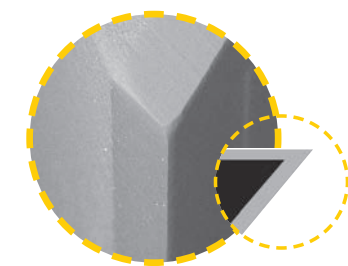

Laser-Sharpened Diamond Coating

IGUANA
LASER SERIES

($\varnothing 1,57 \pm 0,02$)

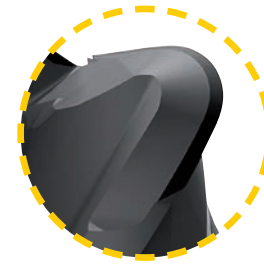

PATENTED DESIGN

SHORT AND STABLE CUTTING EDGES

The tools of the 935 series have a patented cutting edge relief. This means that a cylindrical cutting edge is continued directly behind the corner radius or cutting edge radius in ball or torus end mills, which transitions smoothly into the flute exposure of the tool.

Due to the short cutting edge lengths and simultaneously very long effective lengths of the tools, the efficiency of the tool is considerably increased. This improvement is clearly reflected in the increased surface quality of the component.

IGUANA
LASER SERIES

(∅ 1,57 ±0,02)

15°



INNOVATION BW
INNOVATION
Innovationspreis Baden-Württemberg
Dr.-Rudolf-Eberle-Preis



AWARD-WINNING

IGUANA TECHNOLOGY IS AWARDED THE 2021
BADEN-WÜRTTEMBERG INNOVATION PRIZE

Each year, the Ministry of Economics, Labor and Housing awards the Innovation Prize of the State of Baden-Württemberg (Dr. Rudolf Eberle Prize) for special innovative achievements by medium-sized companies. Exemplary achievements in the development of new products, processes and technological services as well as in the application of modern technologies in products, manufacturing processes and services are honored.

In 2021, ZECHA Hartmetall-Werkzeugfabrikation GmbH won the top prize of the State Innovation Award for this evolution in diamond-coating-processing, highlighting not only the uniqueness but also the importance of this innovation for the manufacturing field.

anzelheit A



THE IGUANA MILLING CHALLENGE

THE ULTIMATE TEST OF THE TECHNOLOGY...
STREAMED LIVE

ZECHA Hartmetall-Werkzeugfabrikation GmbH and AlienTools GmbH went live for the first time in the company's history to find out: "How long will our IGUANA tool run?"

Never before had anyone in the industry taken on such a challenge and live-streamed a long-term milling test.

The goal was clear: one tool, one machine and just let it run.

During the live event, medals in various designs were milled non-stop from 50 x 50 mm copper blanks (E-CU - CW004A), using just a single 1-mm ball end mill from the IGUANA family.

The tool ran so long that the test was proactively terminated after 30 days to free up the in-house KERN milling machine for further projects. In the end, the tool had 641+ hours of milling and a milled distance of over 27 km traveled. Almost unimaginable when you consider the distance covered by the tool, which was only 5 cm long. Thus, the IGUANA microtool milled itself 546,288 times during the live event. Compared to Germany's tallest structure, the tool managed to mill the length of the Berlin TV tower 74.2 times.

For more info on the event, the tool and its performance, scan the QR Code to the left to see highlights from the event and a detailed analysis of the tool and workpieces throughout the event.

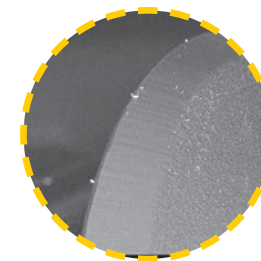
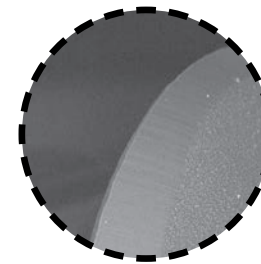

The cutting edge at the start of the event (left), vs. the same cutting edge after 641+ hours (right).



The first coin milled in the event (left), vs. the last coin milled during the event (right).

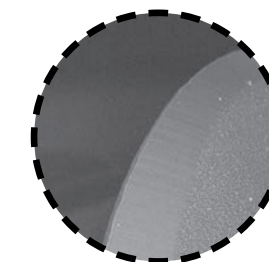

IGUANA
LASER SERIES

(\varnothing 1,57 ±0,02)

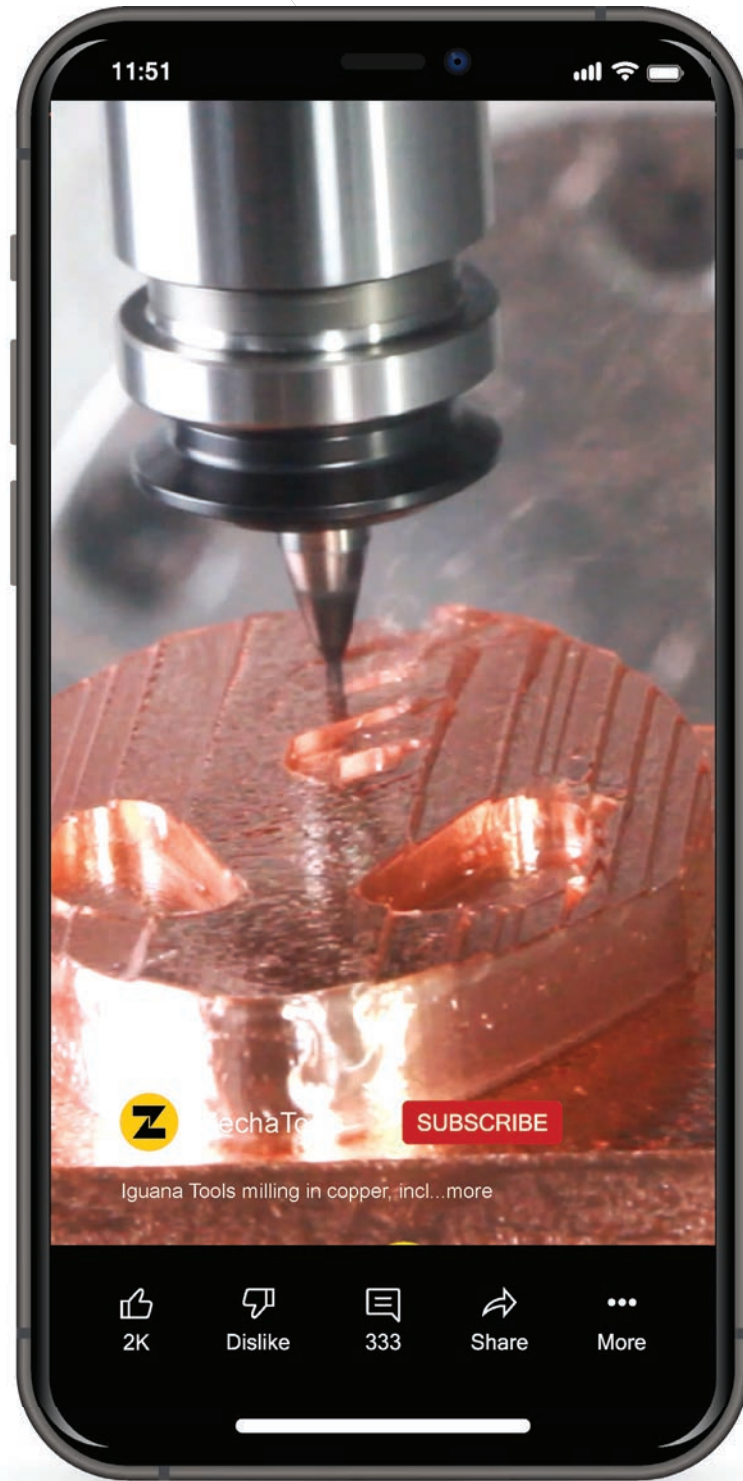

SEE IT IN ACTION

MILLING EXAMPLE OF A COPPER ELECTRODE

Curious to see IGUANA tool technology in action? It's as easy as scanning the QR code below. With just a quick scan, you'll find yourself on a YouTube video where IGUANA tools skillfully mill a copper electrode. Watch and explore the effortless precision and durability that defines the IGUANA LASER SERIES, and get a glimpse of the future of tooling.



IGUANA LASER SERIES

(∅ 1,57 ±0,02)

SERIES OPTIONS

Numerous variations are available in the IGUANA LASER SERIES, which we will break down for you below. Here you will find a brief explanation of the different tool series as well as relevant symbols for the properties of the tools. More information about the series and a key explaining the different symbols can be found on the following pages.

902 SERIES

2-flute ball-nose end mills,
two-sided laser-sharpened coating



- ALU
- AU
- CU
- CU-BE
- CU-ZN
- DIA**
- FVW
- P
- PB
- Pt

903 SERIES

2-flute ball-nose end mills,
one-sided laser-sharpened coating

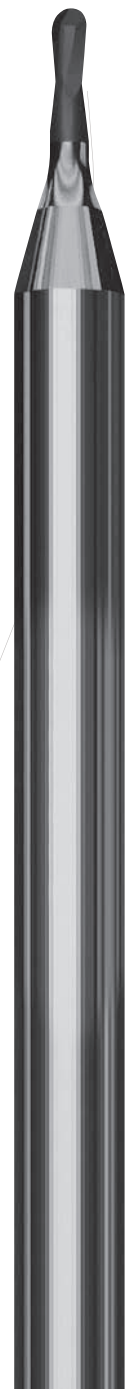

- ALU
- AU
- CU
- CU-BE
- CU-ZN
- DIA**
- FVW
- P
- PB
- Pt

912 SERIES

2-flute bull-nose (toric) end mills,
two-sided laser-sharpened coating



- ALU
- AU
- CU
- CU-BE
- CU-ZN
- DIA**
- FVW
- P
- PB
- Pt

913 SERIES

2-flute bull-nose (toric) end mills,
one-sided laser-sharpened coating



- ALU
- AU
- CU
- CU-BE
- CU-ZN
- DIA**
- FVW
- P
- PB
- Pt

IGUANA LASER SERIES

($\varnothing 1,57 \pm 0,02$)

SERIES OPTIONS

915 SERIES

3-flute flat end mills,
two-sided laser-sharpened coating



- ALU
- AU
- CU
- CU BE
- CU ZN
- DIA
- FVW
- P
- PB
- Pt

916 SERIES

3-flute flat end mills,
one-sided laser-sharpened coating

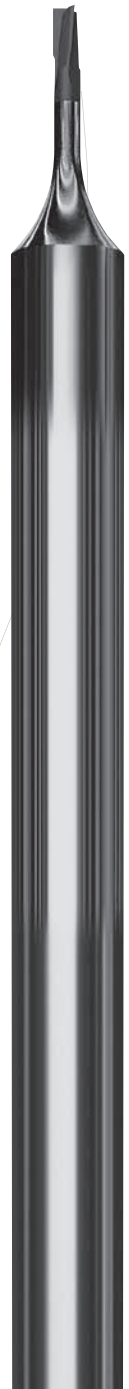

- ALU
- AU
- CU
- CU BE
- CU ZN
- DIA
- FVW
- P
- PB
- Pt

918 SERIES

3-flute flat end mills with shank coolant,
two-sided laser-sharpened coating



- ALU
- AU
- CU
- CU BE
- CU ZN
- DIA
- FVW
- P
- PB
- Pt

930.B2 SERIES

2-flute helix ball-nose end mills,
one-sided laser-sharpened coating



- ALU
- AU
- CU
- CU BE
- CU ZN
- DIA
- FVW
- P
- PB
- Pt

IGUANA LASER SERIES

(Ø 1,57 ±0,02)

SERIES OPTIONS

930.T2 SERIES

2-flute helix bull-nose (toric) end mills,
one-sided laser-sharpened coating



- ALU
- AU
- CU
- DIA**
-
-
-
-
-

- CU BE
- CU ZN
- FVW
- P
- ~~PB~~
- Pt

15°

930.F3 SERIES

3-flute helix flat end mills,
one-sided laser-sharpened coating



- ALU
- AU
- CU
- DIA**
-
-
-
-
-

- CU BE
- CU ZN
- FVW
- P
- ~~PB~~
- Pt

931.T3 SERIES

3-flute helix bull-nose (toric) end mills with shaft
coolant, two-sided laser-sharpened coating



- ALU
- DIA**
-
-
-
-
-
-

- AU
- CU
- CU BE
- CU ZN
- FVW
- P
- ~~PB~~
- Pt

935.B2 SERIES

2-flute helix ball-nose end mills,
two-sided laser-sharpened coating

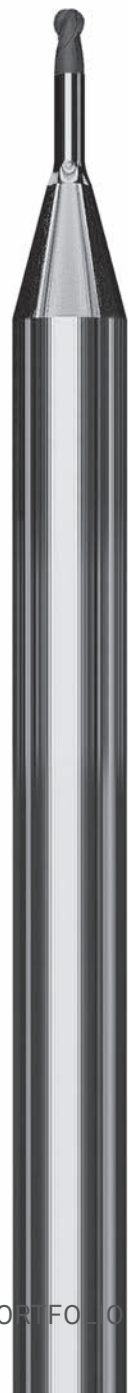

- ALU
- AU
- CU
- DIA**
-
-
-
-
-

- CU BE
- CU ZN
- FVW
- P
- ~~PB~~
- Pt

IGUANA LASER SERIES

(\emptyset 1,57 ±0,02)

SERIES OPTIONS

935.T2 SERIES

2-flute helix end mills with corner radius,
two-sided laser-sharpened coating



15°

- ALU
- AU
- CU
- DIA**
- CU-BE
- CU-ZN
- FVW
- P
- PB
- Pt

935.T3 SERIES

3-flute helix end mills with corner radius,
two-sided laser-sharpened coating



- ALU
- AU
- CU
- DIA**
- CU-BE
- CU-ZN
- FVW
- P
- PB
- Pt

975 SERIES

2-flute twist drill with degressive spiralization,
X-point, one-sided laser-sharpened coating



- ALU
- AU
- CU
- CU-BE
- CU-ZN
- DIA**
- FVW
- P
- PB
- Pt

Einzelheit A

IGUANA LASER SERIES

(Ø 1,57 ±0,02)

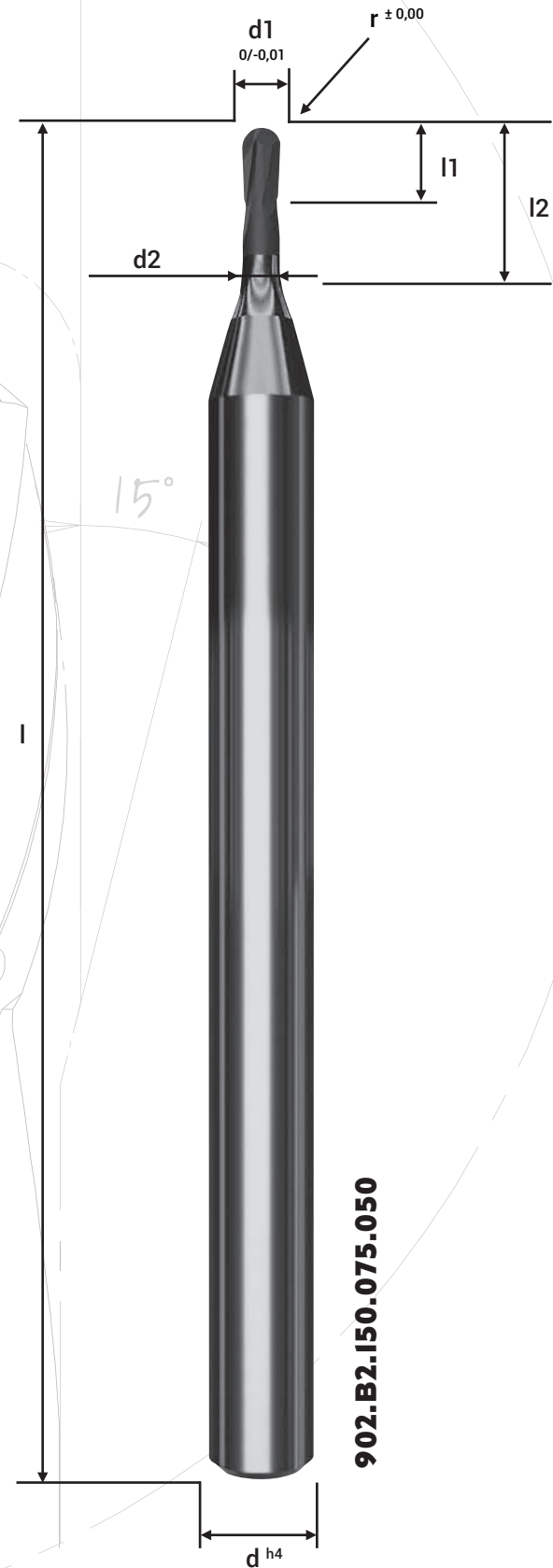

902.B2.150.075.050

d^{h4}

IGUANA 902 SERIES

- 2-flute ball-nose end mill, 5° angled flutes
- Two-sided laser-sharpened Diamond Coating
- For wet finishing of non-ferrous metals
- Neck extension or reduction of the total length upon request

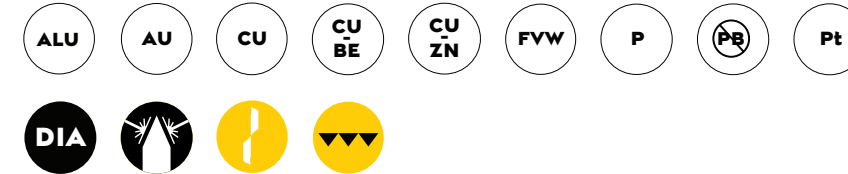

Article No.	d1	d2	r	l1	l2	d	l	z	Inclination Angle				
									30'	1°	1° 30'	2°	3°
902.B2.040.020.015	0.4	0.36	0.20	0.6	1.5	4.0	50	2	2.05	2.19	2.32	2.44	2.67
902.B2.050.025.025	0.5	0.46	0.25	0.7	2.5	4.0	50	2	3.12	3.30	3.47	3.62	3.89
902.B2.060.030.020	0.6	0.55	0.30	1.0	2.0	4.0	50	2	2.62	2.77	2.92	3.05	3.29
902.B2.080.040.020	0.8	0.75	0.40	1.2	2.0	4.0	50	2	2.61	2.76	2.90	3.03	3.27
902.B2.100.050.050	1.0	0.94	0.50	1.6	5.0	4.0	50	2	5.82	6.07	6.29	6.48	6.82
902.B2.150.075.050	1.5	1.40	0.75	2.4	5.0	4.0	50	2	5.92	6.14	6.34	6.52	6.84
902.B2.200.100.060	2.0	1.90	1.00	3.0	6.0	4.0	50	2	6.95	7.20	7.41	7.60	7.94
902.B2.300.150.090	3.0	2.80	1.50	3.5	9.0	4.0	50	2	10.27	10.54	10.78	10.99	11.36

IGUANA 903 SERIES

- 2-flute ball-nose end mill, 5° angled flutes
- One-sided laser-sharpened Diamond Coating
- For wet finishing of non-ferrous metals
- Neck extension or reduction of the total length upon request

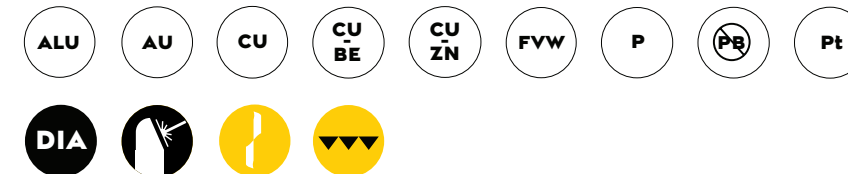

Article No.	d1	d2	r	l1	l2	d	l	z	Inclination Angle				
									30'	1°	1° 30'	2°	3°
903.B2.040.020.015	0.4	0.36	0.20	0.6	1.5	4.0	50	2	2.05	2.19	2.32	2.44	2.67
903.B2.050.025.025	0.5	0.46	0.25	0.7	2.5	4.0	50	2	3.12	3.30	3.47	3.62	3.89
903.B2.060.030.020	0.6	0.55	0.30	1.0	2.0	4.0	50	2	2.62	2.77	2.92	3.05	3.29
903.B2.080.040.020	0.8	0.75	0.40	1.2	2.0	4.0	50	2	2.61	2.76	2.90	3.03	3.27
903.B2.100.050.050	1.0	0.94	0.50	1.6	5.0	4.0	50	2	5.82	6.07	6.29	6.48	6.82
903.B2.150.075.050	1.5	1.40	0.75	2.4	5.0	4.0	50	2	5.92	6.14	6.34	6.52	6.84
903.B2.200.100.060	2.0	1.90	1.00	3.0	6.0	4.0	50	2	6.95	7.20	7.41	7.60	7.94
903.B2.300.150.090	3.0	2.80	1.50	3.5	9.0	4.0	50	2	10.27	10.54	10.78	10.99	11.36

IGUANA LASER SERIES

(Ø 1,57 ±0,02)

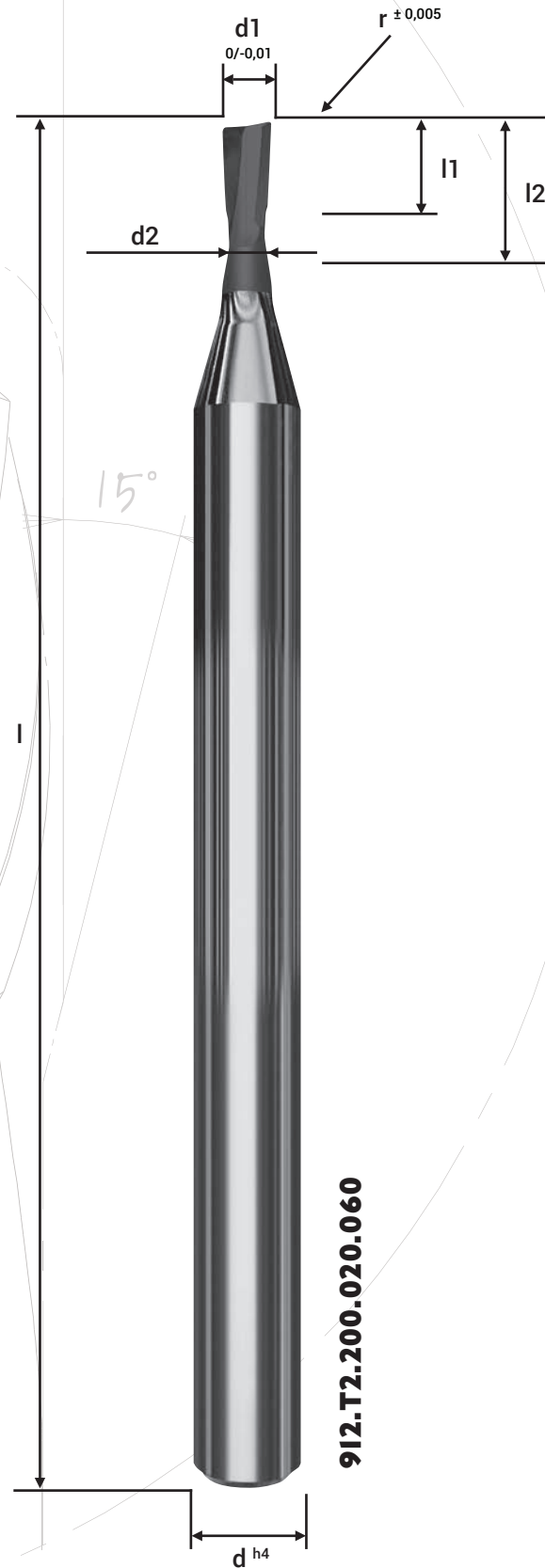

912.T2.200.020.060

IGUANA 912 SERIES

- 2-flute bull-nose (toric) end mill, 5° angled flutes
- Two-sided laser-sharpened Diamond Coating
- For wet finishing of non-ferrous metals
- Neck extension or reduction of the total length upon request

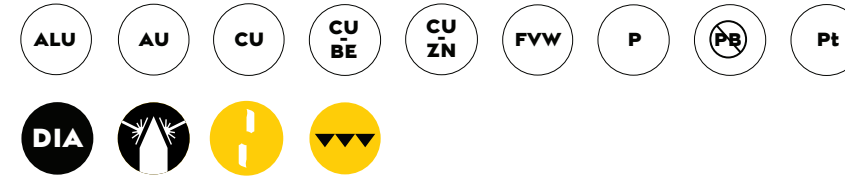

Article No.	d1	d2	r	l1	l2	d	l	z	Inclination Angle				
									30'	1°	1° 30'	2°	3°
912.T2.050.005.025	0.5	0.46	0.05	0.7	2.5	4.0	50	2	3.13	3.33	3.50	3.65	3.93
912.T2.100.010.050	1.0	0.94	0.10	1.5	5.0	4.0	50	2	5.84	6.10	6.33	6.53	6.88
912.T2.150.015.050	1.5	1.40	0.15	2.4	5.0	4.0	50	2	5.95	6.19	6.40	6.59	6.93
912.T2.200.020.060	2.0	1.90	0.20	3.0	6.0	4.0	50	2	6.99	7.26	7.49	7.69	8.06
912.T2.300.030.090	3.0	2.80	0.30	3.5	9.0	4.0	50	2	10.31	10.61	10.87	11.10	-

IGUANA 913 SERIES

- 2-flute bull-nose (toric) end mill, 5° angled flutes
- One-sided laser-sharpened Diamond Coating
- For wet finishing of non-ferrous metals
- Neck extension or reduction of the total length upon request

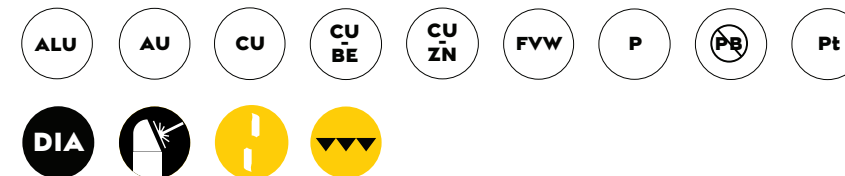

Article No.	d1	d2	r	l1	l2	d	l	z	Inclination Angle				
									30'	1°	1° 30'	2°	3°
913.T2.050.005.025	0.5	0.46	0.05	0.7	2.5	4.0	50	2	3.13	3.33	3.50	3.65	3.93
913.T2.100.010.050	1.0	0.94	0.10	1.6	5.0	4.0	50	2	5.84	6.10	6.33	6.53	6.88
913.T2.150.015.050	1.5	1.40	0.15	2.4	5.0	4.0	50	2	5.95	6.19	6.40	6.59	6.93
913.T2.200.020.060	2.0	1.90	0.20	3.0	6.0	4.0	50	2	6.99	7.26	7.49	7.69	8.06
913.T2.300.030.090	3.0	2.80	0.30	3.5	9.0	4.0	50	2	10.31	10.61	10.87	11.10	-

IGUANA LASER SERIES

($\varnothing 1,57 \pm 0,02$)

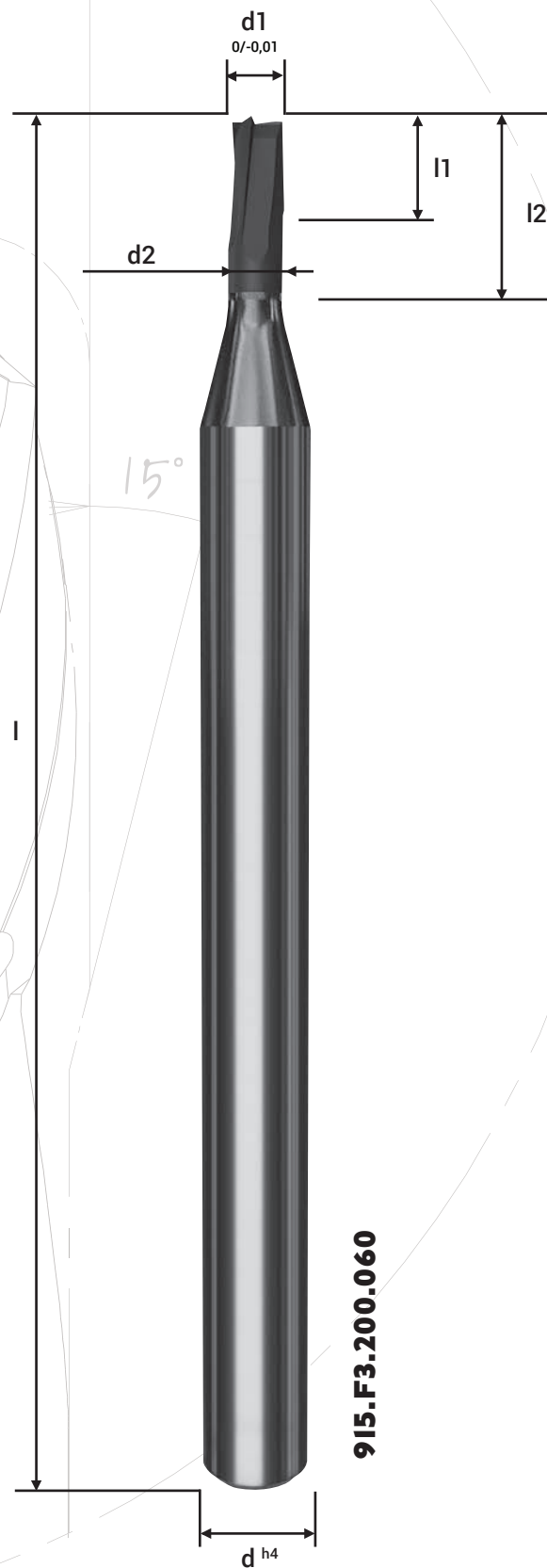

915.F3.200.060

IGUANA 915 SERIES

- 3-flute flat end mill, 5° angled flutes
- Two-sided laser-sharpened Diamond Coating
- For wet finishing of non-ferrous metals
- Neck extension or reduction of the total length upon request

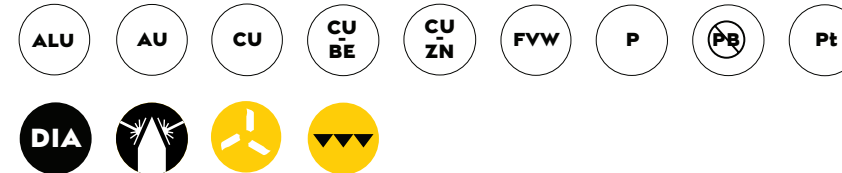

Article No.	d1	d2	l1	l2	d	l	z	Inclination Angle				
								30'	1°	1° 30'	2°	3°
915.F3.050.025	0.5	0.46	0.7	2.5	4.0	50	3	3.14	3.33	3.50	3.66	3.95
915.F3.100.050	1.0	0.94	1.5	5.0	4.0	50	3	5.85	6.11	6.34	6.54	6.90
915.F3.150.050	1.5	1.40	2.4	5.0	4.0	50	3	5.95	6.20	6.42	6.61	6.95
915.F3.200.060	2.0	1.90	3.0	6.0	4.0	50	3	7.00	7.27	7.51	7.72	8.08
915.F3.300.090	3.0	2.80	3.5	9.0	4.0	50	3	10.32	10.61	10.89	11.12	-

IGUANA 916 SERIES

- 3-flute flat end mill, 5° angled flutes
- One-sided laser-sharpened Diamond Coating
- For wet finishing of non-ferrous metals
- Neck extension or reduction of the total length upon request

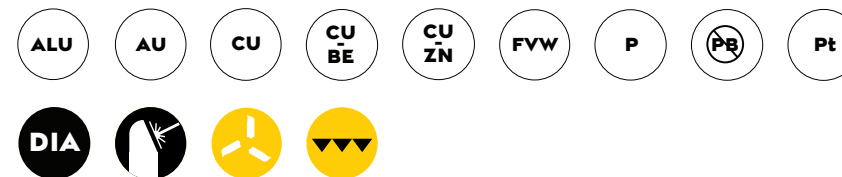

Article No.	d1	d2	l1	l2	d	l	z	Inclination Angle				
								30'	1°	1° 30'	2°	3°
916.F3.050.025	0.5	0.46	0.7	2.5	4.0	50	3	3.14	3.33	3.50	3.66	3.95
916.F3.100.050	1.0	0.94	1.6	5.0	4.0	50	3	5.85	6.11	6.34	6.54	6.90
916.F3.150.050	1.5	1.40	2.4	5.0	4.0	50	3	5.95	6.20	6.42	6.61	6.95
916.F3.200.060	2.0	1.90	3.0	6.0	4.0	50	3	7.00	7.27	7.51	7.72	8.08
916.F3.300.090	3.0	2.80	3.5	9.0	4.0	50	3	10.32	10.61	10.89	11.12	-

IGUANA
LASER SERIES

(\emptyset 1,57 \pm 0,02)

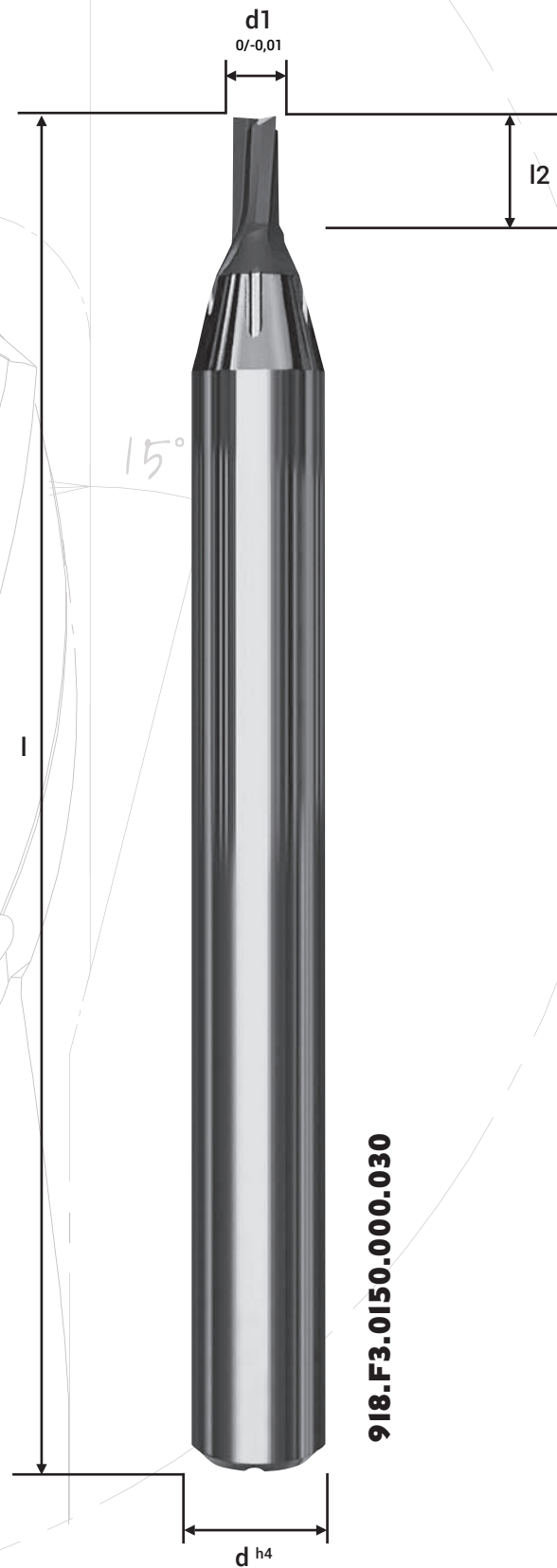

918.F3.0150.000.030

IGUANA 918 SERIES

- 3-flute flat end mill, and 5° angled flutes, shaft coolant
- Two-sided laser-sharpened Diamond Coating
- For wet finishing of non-ferrous metals
- Neck extension or reduction of the total length upon request



Article No.	d1	l1	d	l	z	Inclination Angle				
						30'	1°	1° 30'	2°	3°
918.F3.0040.000.008	0.4	0.8	4.0	39	3	1.11	1.27	1.41	1.53	1.75
918.F3.0050.000.010	0.5	1.0	4.0	39	3	1.34	1.51	1.66	1.79	2.02
918.F3.0070.000.014	0.7	1.4	4.0	39	3	1.80	1.99	2.15	2.29	2.55
918.F3.0080.000.016	0.8	1.6	4.0	39	3	2.02	2.22	2.39	2.54	2.80
918.F3.0100.000.020	1.0	2.0	4.0	39	3	2.46	2.68	2.86	3.02	3.30
918.F3.0120.000.024	1.2	2.4	4.0	39	3	2.90	3.14	3.33	3.50	3.80
918.F3.0150.000.030	1.5	3.0	4.0	39	3	3.56	3.81	4.02	4.20	4.52
918.F3.0160.000.032	1.6	3.2	4.0	39	3	3.77	4.04	4.25	4.43	4.76
918.F3.0200.000.040	2.0	4.0	4.0	39	3	4.63	4.92	5.15	5.35	5.70

IGUANA
LASER SERIES

(\emptyset 1,57 ±0,02)



930.B2.0200.100.060

IGUANA 930.B2 SERIES

- 2-flute ball-nose end mill, helix flutes and 25° angled flutes
- One-sided laser-sharpened Diamond Coating
- For wet semi-finishing or finishing of non-ferrous metals
- Neck extension or reduction of the total length upon request

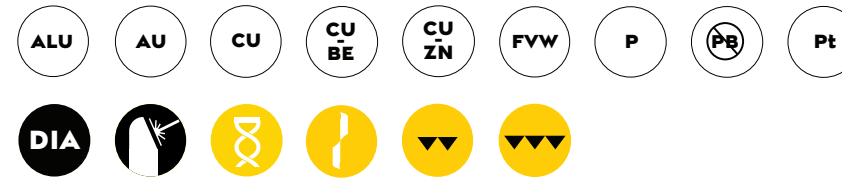

Article No.	d1	d2	r	l1	l2	d	l	z	Inclination Angle				
									30'	1°	1° 30'	2°	3°
930.B2.0050.025.015	0.5	0.46	0.25	0.5	1.5	4.0	50	2	2.12	2.30	2.47	2.62	2.89
930.B2.0100.050.030	1.0	0.94	0.50	1.0	3.0	4.0	50	2	3.82	4.07	4.29	4.48	4.82
930.B2.0150.075.045	1.5	1.40	0.75	1.5	4.5	4.0	50	2	5.42	5.64	5.84	6.02	6.34
930.B2.0200.100.060	2.0	1.90	1.00	2.0	6.0	4.0	50	2	6.95	7.41	7.41	7.60	7.94
930.B2.0300.150.090	3.0	2.80	1.50	3.0	9.0	4.0	50	2	10.27	10.54	10.78	10.99	11.36

IGUANA LASER SERIES

($\emptyset 1,57 \pm 0,02$)



930.T2.0200.020.060

IGUANA 930.T2 SERIES

- 2-flute bull-nose (toric) end mill, helix flutes and 25° angled flutes
- One-sided laser-sharpened Diamond Coating
- For wet semi-finishing or finishing of non-ferrous metals
- Neck extension or reduction of the total length upon request



Article No.	d1	d2	r	l1	l2	d	l	z	Inclination Angle				
									30'	1°	1° 30'	2°	3°
930.T2.0050.005.015	0.5	0.46	0.05	0.5	1.5	4.0	50	2	2.13	2.33	2.50	2.65	2.95
930.T2.0100.010.030	1.0	0.94	0.10	1.0	3.0	4.0	50	2	3.84	4.10	4.33	4.53	4.88
930.T2.0150.010.045	1.5	1.40	0.10	1.5	4.5	4.0	50	2	5.45	5.69	5.90	6.09	6.44
930.T2.0200.020.060	2.0	1.90	0.20	2.0	6.0	4.0	50	2	6.99	7.26	7.49	7.69	8.06
930.T2.0300.030.090	3.0	2.80	0.30	3.0	9.0	4.0	50	2	10.31	10.61	10.87	11.10	-

IGUANA
LASER SERIES

($\emptyset 1,57 \pm 0,02$)

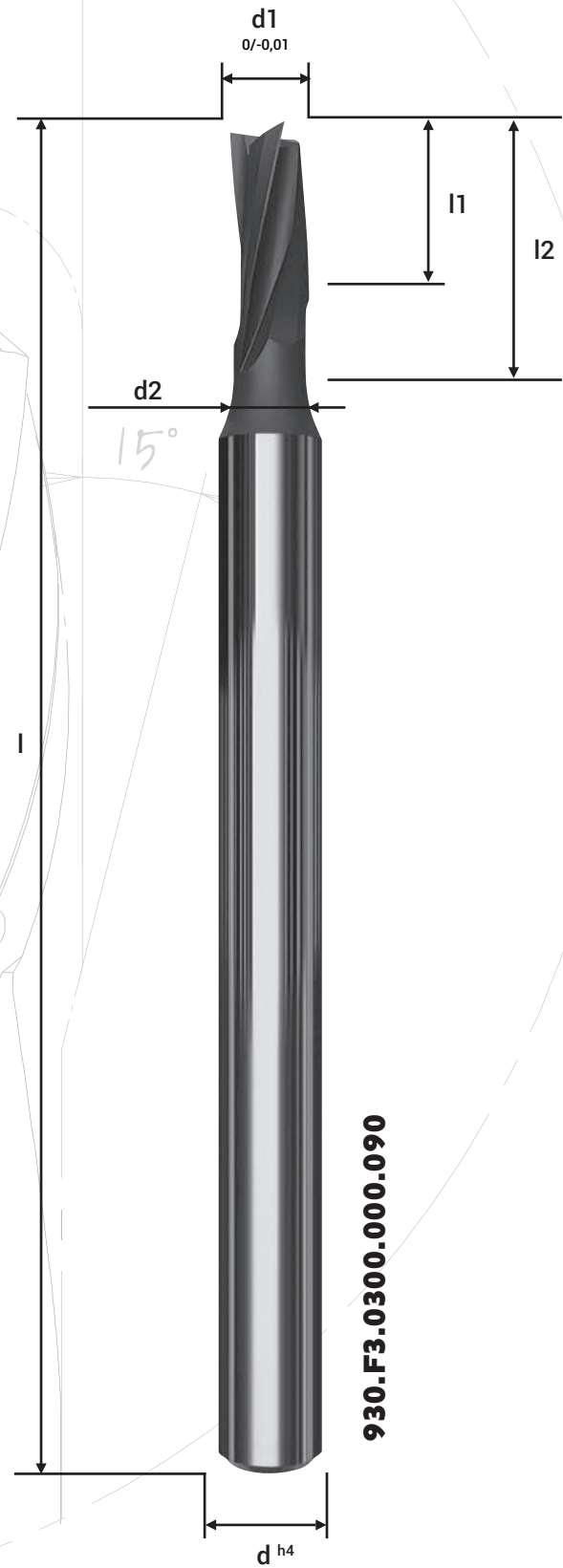

930.F3.0300.000.090

IGUANA 930.F3 SERIES

- 3-flute flat end mill, helix flutes and 12° angled flutes
- One-sided laser-sharpened Diamond Coating
- For wet semi-finishing or finishing of non-ferrous metals
- Neck extension or reduction of the total length upon request

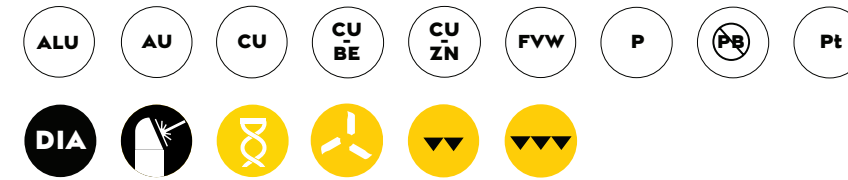

Article No.	d1	d2	l1	l2	d	l	z	Inclination Angle				
								30'	1°	1° 30'	2°	3°
930.F3.0100.000.030	1.0	0.94	2.0	3.0	4.0	50	3	4.85	5.11	5.34	5.54	5.90
930.F3.0150.000.045	1.5	1.40	3.0	4.5	4.0	50	3	5.45	5.70	5.92	6.11	6.45
930.F3.0200.000.060	2.0	1.90	4.0	6.0	4.0	50	3	7.00	7.27	7.51	7.72	8.08
930.F3.0300.000.090	3.0	2.80	6.0	9.0	4.0	50	3	10.62	10.62	10.89	11.12	-
930.F3.0400.000.120	4.0	3.80	8.0	12.0	6.0	60	3	13.41	13.75	14.04	13.30	15.02
930.F3.0600.000.180	6.0	5.90	12.0	18.0	6.0	60	3	-	-	-	-	-

IGUANA
LASER SERIES

($\emptyset 1,57 \pm 0,02$)

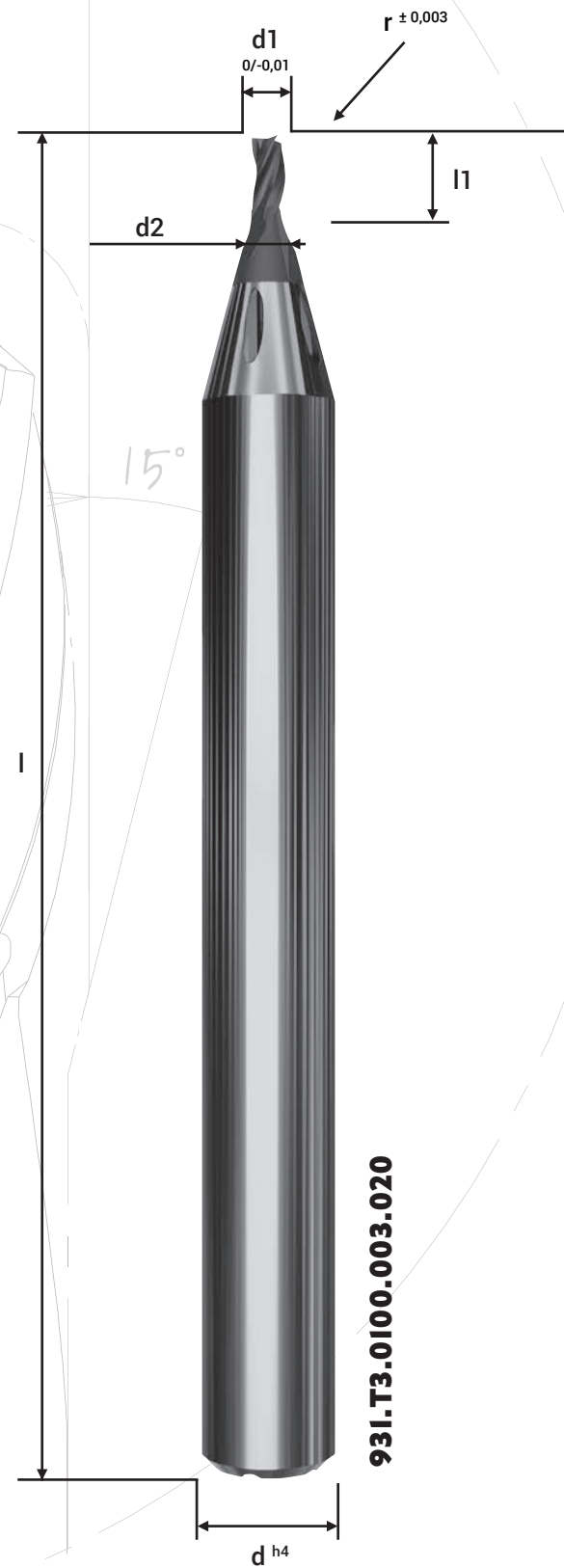

931.T3.0100.003.020

IGUANA 931.T3 SERIES

- 3-flute bull-nose (toric) end mill, helix flutes, shaft coolant and 25° angled flutes
- Two-sided laser-sharpened Diamond Coating
- For wet roughing, semi-finishing or finishing of non-ferrous metals
- Neck extension or reduction of the total length upon request

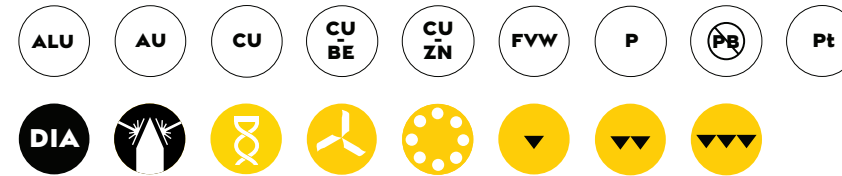

Article No.	d1	r	l1	d	l	z	Inclination Angle				
							30'	1°	1° 30'	2°	3°
931.T3.0050.003.010	0,5	0,03	1,0	4,0	39	3	1,47	1,58	1,66	1,74	1,87
931.T3.0080.003.016	0,8	0,03	1,6	4,0	39	3	2,12	2,24	2,34	2,42	2,57
931.T3.0100.003.020	1,0	0,03	2,0	4,0	39	3	2,54	2,68	2,78	2,87	3,03
931.T3.0120.003.024	1,2	0,03	2,4	4,0	39	3	2,86	3,00	3,11	3,21	3,37
931.T3.0150.003.030	1,5	0,03	3,0	4,0	39	3	3,49	3,65	3,77	3,87	4,04
931.T3.0200.005.040	2,0	0,05	4,0	4,0	39	3	4,54	4,71	4,85	4,96	5,19
931.T3.0300.005.050	3,0	0,05	5,0	6,0	50	3	6,62	6,83	6,98	7,11	7,69
931.T3.0400.005.060	4,0	0,05	6,0	6,0	50	3	8,86	8,92	9,09	9,40	10,19

IGUANA
LASER SERIES

(Ø 1,57 ±0,02)

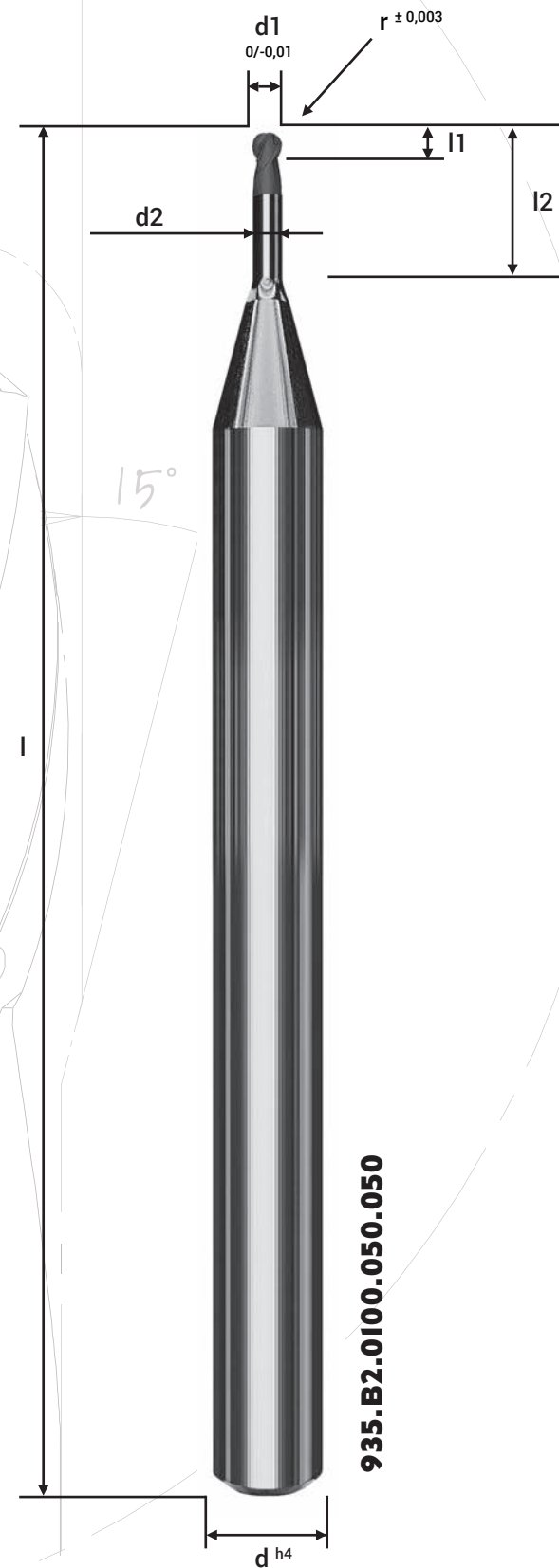

935.B2.0100.050.050

IGUANA 935.B2 SERIES

- 2-flute ball-nose end mill, helix flutes and 25° angled flutes
- Patented cutting geometry EP 2540427B1*
- Two-sided laser-sharpened Diamond Coating
- For wet semi-finishing or finishing of non-ferrous metals
- Neck extension or reduction of the total length upon request

ALU AU CU CU BE CU ZN FVW P PB Pt
DIA



Article No.	d1	d2	r	l1	l2	d	l	z	Inclination Angle				
									30'	1°	1° 30'	2°	3°
935.B2.0030.015.008	0,3	0,24	0,15	0,35	0,8	4,0	50	2	1,14	1,19	1,23	1,28	1,36
935.B2.0030.015.010	0,3	0,24	0,15	0,35	1,0	4,0	50	2	1,35	1,40	1,46	1,50	1,60
935.B2.0030.015.015	0,3	0,24	0,15	0,35	1,5	4,0	50	2	1,87	1,94	2,01	2,07	2,18
935.B2.0030.015.020	0,3	0,24	0,15	0,35	2,0	4,0	50	2	2,39	2,48	2,56	2,63	2,75
935.B2.0030.015.030	0,3	0,24	0,15	0,35	3,0	4,0	50	2	3,43	3,54	3,64	3,73	3,88
935.B2.0040.020.008	0,4	0,34	0,20	0,35	0,8	4,0	50	2	1,14	1,18	1,23	1,27	1,35
935.B2.0040.020.012	0,4	0,34	0,20	0,35	1,2	4,0	50	2	1,56	1,62	1,67	1,72	1,82
935.B2.0040.020.020	0,4	0,34	0,20	0,35	2,0	4,0	50	2	2,39	2,47	2,55	2,62	2,75
935.B2.0040.020.040	0,4	0,34	0,20	0,35	4,0	4,0	50	2	4,46	4,60	4,71	4,81	4,96
935.B2.0050.025.008	0,5	0,44	0,25	0,35	0,8	4,0	50	2	1,13	1,18	1,22	1,26	1,34
935.B2.0050.025.020	0,5	0,44	0,25	0,35	2,0	4,0	50	2	2,39	2,47	2,55	2,61	2,74
935.B2.0050.025.025	0,5	0,44	0,25	0,35	2,5	4,0	50	2	2,91	3,00	3,09	3,17	3,31
935.B2.0050.025.030	0,5	0,44	0,25	0,35	3,0	4,0	50	2	3,43	3,54	3,63	3,72	3,86
935.B2.0050.025.040	0,5	0,44	0,25	0,35	4,0	4,0	50	2	4,46	4,59	4,70	4,80	4,96
935.B2.0050.025.050	0,5	0,44	0,25	0,35	5,0	4,0	50	2	5,49	5,64	5,77	5,88	6,21
935.B2.0050.025.060	0,5	0,44	0,25	0,35	6,0	4,0	50	2	6,53	6,69	6,83	6,89	7,46
935.B2.0060.030.009	0,6	0,54	0,30	0,40	0,9	4,0	50	2	1,24	1,28	1,33	1,37	1,45
935.B2.0060.030.030	0,6	0,54	0,30	0,40	3,0	4,0	50	2	3,42	3,53	3,63	3,71	3,86
935.B2.0060.030.040	0,6	0,54	0,30	0,40	3,0	4,0	50	2	4,46	4,59	4,70	4,80	4,96
935.B2.0060.030.060	0,6	0,54	0,30	0,40	6,0	4,0	50	2	6,52	6,69	6,83	6,94	7,46
935.B2.0060.030.090	0,6	0,54	0,30	0,40	9,0	4,0	50	2	9,61	9,82	9,97	10,35	11,21
935.B2.0080.040.012	0,8	0,74	0,40	0,50	1,2	4,0	50	2	1,55	1,60	1,65	1,70	1,79
935.B2.0080.040.020	0,8	0,74	0,40	0,50	2,0	4,0	50	2	2,38	2,46	2,53	2,60	2,72
935.B2.0080.040.040	0,8	0,74	0,40	0,50	4,0	4,0	50	2	4,46	4,58	4,69	4,79	4,95
935.B2.0080.040.060	0,8	0,74	0,40	0,50	6,0	4,0	50	2	6,50	6,67	6,80	6,92	7,44
935.B2.0080.040.080	0,8	0,74	0,40	0,50	8,0	4,0	50	2	8,58	8,77	8,93	9,19	9,95
935.B2.0100.050.015	1,0	0,95	0,50	0,80	1,5	4,0	50	2	1,83	1,89	1,95	2,00	2,10
935.B2.0100.050.030	1,0	0,95	0,50	0,80	3,0	4,0	50	2	3,39	3,50	3,59	3,68	3,82
935.B2.0100.050.050	1,0	0,95	0,50	0,80	5,0	4,0	50	2	5,47	5,62	5,74	5,85	6,19
935.B2.0100.050.060	1,0	0,95	0,50	0,80	6,0	4,0	50	2	6,50	6,67	6,80	6,92	7,44
935.B2.0100.050.080	1,0	0,95	0,50	0,80	8,0	4,0	50	2	8,56	8,76	8,91	9,18	9,94

*DE, AT, CH, LIE, CZ, FR, GB, IT, NL, PL, PT, TR

continued on next page...

Einzelheit A

IGUANA
LASER SERIES

($\emptyset 1,57 \pm 0,02$)

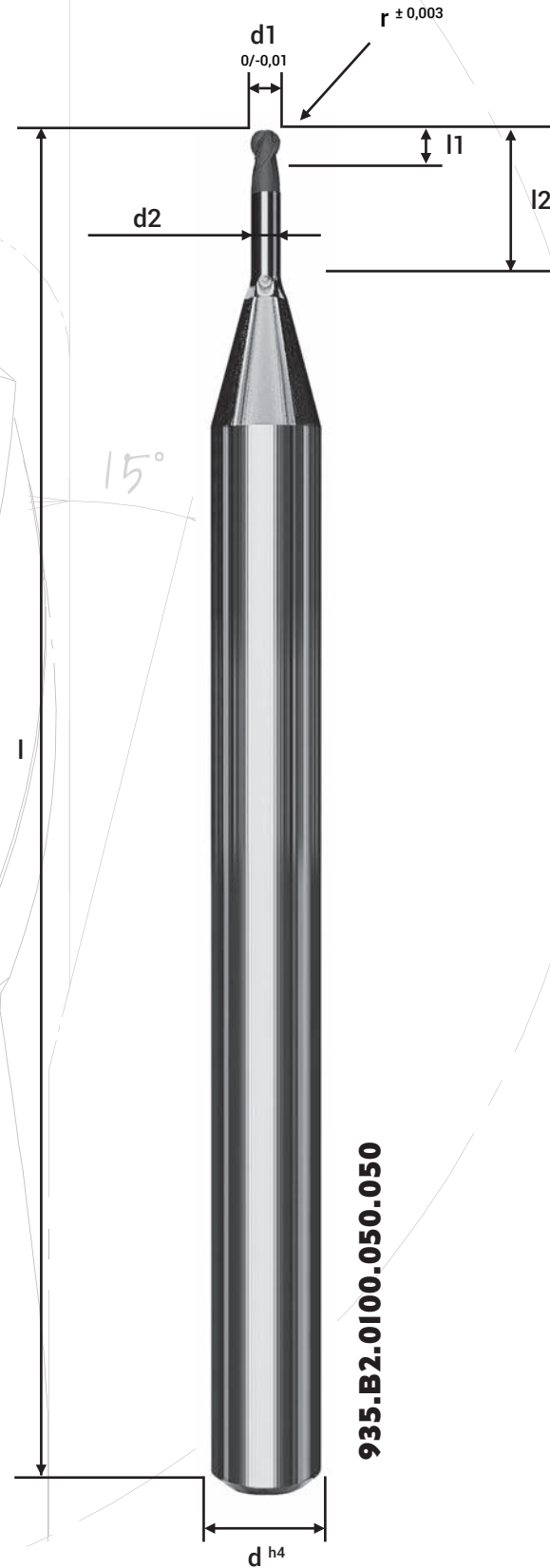

IGUANA 935.B2 SERIE...FORTSETZUNG

Article No.	d1	d2	r	l1	l2	d	l	z	Inclination Angle				
									30'	1°	1° 30'	2°	3°
935.B2.0100.050.100	1,0	0,95	0,50	0,80	10,0	4,0	50	2	10,61	10,83	11,07	11,49	12,44
935.B2.0100.050.150	1,0	0,95	0,50	0,80	15,0	4,0	50	2	15,73	16,03	16,62	17,26	18,69
935.B2.0150.075.025	1,5	1,42	0,75	1,05	2,5	4,0	50	2	2,93	3,01	3,08	3,14	3,26
935.B2.0150.075.050	1,5	1,42	0,75	1,05	5,0	4,0	50	2	5,51	5,65	5,76	5,86	6,20
935.B2.0150.075.080	1,5	1,42	0,75	8,0	5,0	4,0	50	2	8,60	8,78	8,93	9,19	9,95
935.B2.0150.075.100	1,5	1,42	0,75	1,05	10,0	4,0	50	2	10,65	10,86	11,08	11,50	12,45
935.B2.0150.075.150	1,5	1,42	0,75	1,05	15,0	4,0	50	2	15,73	16,04	16,63	17,27	18,70
935.B2.0150.075.200	1,5	1,42	0,75	1,05	20,0	4,0	50	2	20,86	21,40	22,19	23,04	-
935.B2.0200.100.030	2,0	1,92	1,00	1,30	3,0	4,0	50	2	3,44	3,52	3,60	3,67	3,79
935.B2.0200.100.060	2,0	1,92	1,00	1,30	6,0	4,0	50	2	6,54	6,68	6,81	6,91	7,43
935.B2.0200.100.080	2,0	1,92	1,00	1,30	8,0	4,0	50	2	8,25	8,54	8,85	9,18	9,93
935.B2.0200.100.120	2,0	1,92	1,00	1,30	12,0	4,0	50	2	12,69	12,92	13,29	13,80	14,93
935.B2.0200.100.180	2,0	1,92	1,00	1,30	18,0	4,0	60	2	18,91	19,25	19,96	20,72	-
935.B2.0200.100.240	2,0	1,92	1,00	1,30	24,0	4,0	60	2	24,85	25,68	26,63	27,64	-
935.B2.0300.150.060	3,0	2,82	1,50	1,80	6,0	4,0	60	2	6,68	6,79	6,89	6,91	7,46
935.B2.0300.150.090	3,0	2,82	1,50	1,80	9,0	4,0	60	2	9,74	9,90	10,00	10,37	-
935.B2.0300.150.180	3,0	2,82	1,50	1,80	18,0	4,0	60	2	18,91	19,29	20,00	-	-
935.B2.0300.150.240	3,0	2,82	1,50	1,80	24,0	4,0	60	2	24,85	25,72	-	-	-
935.B2.0400.200.080	4,0	3,82	2,00	2,50	8,0	6,0	60	2	8,71	8,85	8,87	9,20	9,93
935.B2.0400.200.120	4,0	3,82	2,00	2,50	12,0	6,0	60	2	12,79	12,86	13,32	13,81	14,93
935.B2.0400.200.240	4,0	3,82	2,00	2,50	24,0	6,0	60	2	24,85	25,71	26,65	27,66	-
935.B2.0500.250.100	5,0	4,82	2,50	3,00	10,0	6,0	60	2	10,74	10,90	11,08	11,49	-
935.B2.0500.250.150	5,0	4,82	2,50	3,00	15,0	6,0	60	2	15,84	16,06	16,64	-	-
935.B2.0500.250.250	5,0	4,82	2,50	3,00	25,0	6,0	60	2	25,88	26,78	-	-	-
935.B2.0600.300.120	6,0	5,82	3,00	3,50	12,0	6,0	60	2	-	-	-	-	-
935.B2.0600.300.180	6,0	5,82	3,00	3,50	18,0	6,0	60	2	-	-	-	-	-
935.B2.0600.300.300	6,0	5,82	3,00	3,50	30,0	6,0	60	2	-	-	-	-	-

IGUANA
LASER SERIES

($\emptyset 1,57 \pm 0,02$)

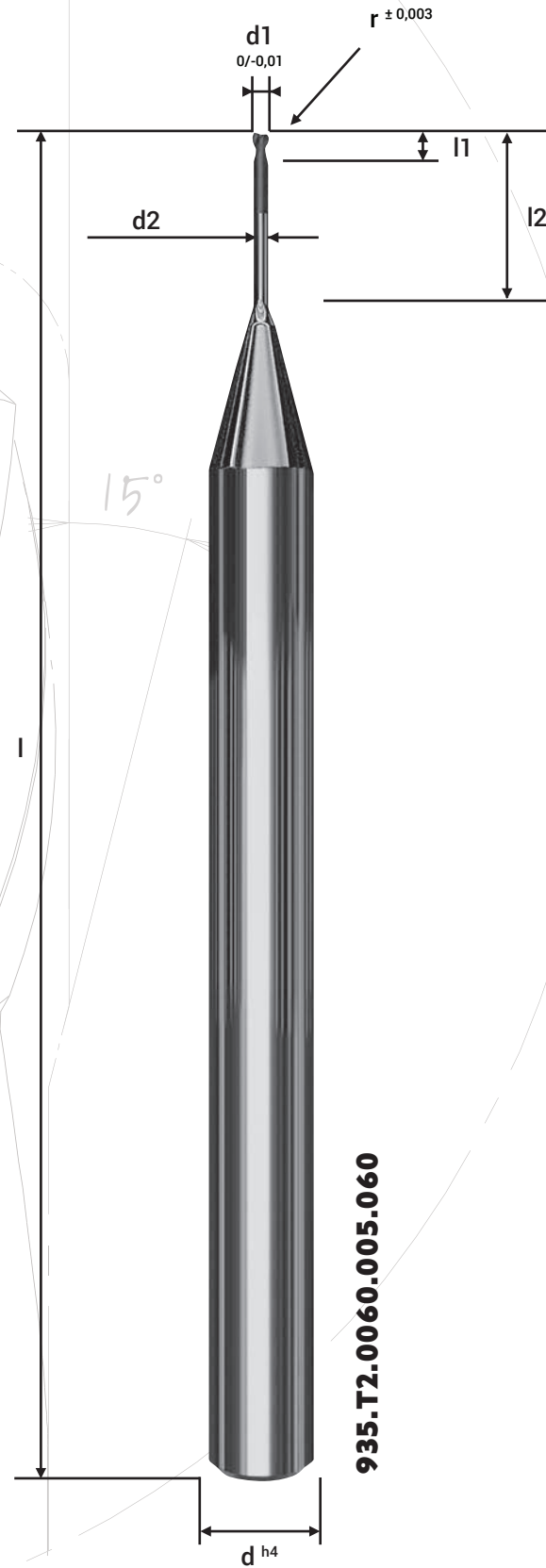

935.T2.0060.005.060

IGUANA 935.T2 SERIES

- 3-flute bull-nose (toric) end mill, helix flutes and ° angled flutes
- Patented cutting geometry EP 2540427B1*
- Two-sided laser-sharpened Diamond Coating
- For wet semi-finishing or finishing of non-ferrous metals
- Neck extension or reduction of the total length upon request

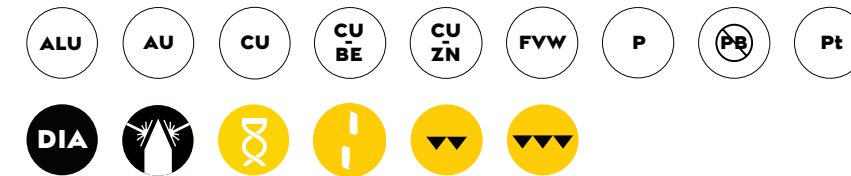

Article No.	d1	d2	r	l1	l2	d	l	z	Inclination Angle				
									30'	1°	1° 30'	2°	3°
935.T2.0050.005.008	0.5	0.44	0.05	0.3	0.8	4.0	50	2	1.14	1.19	1.24	1.29	1.38
935.T2.0050.005.025	0.5	0.44	0.05	0.3	2.5	4.0	50	2	2.91	3.02	3.11	3.19	3.33
935.T2.0050.005.050	0.5	0.44	0.05	0.3	5.0	4.0	50	2	5.50	5.66	5.78	5.89	6.22
935.T2.0050.005.075	0.5	0.44	0.05	0.3	7.5	4.0	50	2	8.07	8.27	8.42	8.63	9.35
935.T2.0050.005.100	0.5	0.44	0.05	0.3	10.0	4.0	50	2	10.64	10.86	11.08	11.51	12.47
935.T2.0060.005.009	0.6	0.54	0.05	0.3	0.9	4.0	50	2	1.25	1.30	1.36	1.40	1.50
935.T2.0060.005.030	0.6	0.54	0.05	0.3	3.0	4.0	50	2	3.43	3.55	3.65	3.73	3.89
935.T2.0060.005.060	0.6	0.54	0.05	0.3	6.0	4.0	50	2	6.53	6.70	6.84	6.90	7.47
935.T2.0080.005.012	0.8	0.74	0.05	0.3	1.2	4.0	50	2	1.56	1.63	1.69	1.74	1.85
935.T2.0080.005.040	0.8	0.74	0.05	0.3	4.0	4.0	50	2	4.47	4.60	4.72	4.82	4.97
935.T2.0080.005.080	0.8	0.74	0.05	0.3	8.0	4.0	50	2	8.59	8.79	8.86	9.20	9.97
935.T2.0080.020.040	0,8	0,74	0,20	0,45	4,0	4,0	50	2	4,47	4,60	4,72	4,82	4,97

*DE, AT, CH, LIE, CZ, FR, GB, IT, NL, PL, PT, TR

IGUANA
LASER SERIES

($\emptyset 1,57 \pm 0,02$)



IGUANA 935.T3 SERIES

- 3-flute bull-nose (toric) end mill, helix flutes and 25° angled flutes
- Patented cutting geometry EP 2540427B1*
- Two-sided laser-sharpened Diamond Coating
- For wet semi-finishing or finishing of non-ferrous metals
- Neck extension or reduction of the total length upon request

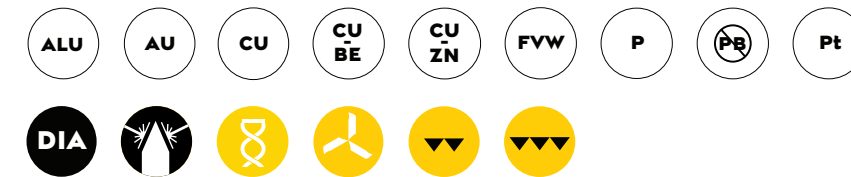

Article No.	d1	d2	r	l1	l2	d	l	z	Inclination Angle				
									30°	1°	1° 30'	2°	3°
935.T3.0100.010.015	1.0	0.95	0.10	0.40	1.5	4.0	50	3	1.85	1.92	1.99	2.06	2.17
935.T3.0100.010.050	1.0	0.95	0.10	0.40	5.0	4.0	50	3	5.48	5.64	5.77	5.88	6.21
935.T3.0100.010.100	1.0	0.95	0.10	0.40	10.0	4.0	50	3	10.62	10.85	11.08	11.50	12.46
935.T3.0100.010.150	1.0	0.95	0.10	0.40	15.0	4.0	50	3	15.74	16.04	16.63	17.27	18.71
935.T3.0100.020.015	1.0	0.95	0.20	0.50	1.5	4.0	50	3	1.84	1.92	1.98	2.04	2.16
935.T3.0100.020.050	1.0	0.95	0.20	0.50	5.0	4.0	50	3	5.48	5.63	5.76	5.87	6.21
935.T3.0100.020.100	1.0	0.95	0.20	0.50	10.0	4.0	50	3	10.62	10.85	11.08	11.50	12.46
935.T3.0100.020.150	1.0	0.95	0.20	0.50	15.0	4.0	50	3	15.74	16.04	16.36	17.27	18.71
935.T3.0150.010.025	1.5	1.42	0.10	0.40	2.5	4.0	50	3	2.95	3.05	3.13	3.21	3.35
935.T3.0150.010.050	1.5	1.42	0.10	0.40	5.0	4.0	50	3	5.53	5.68	5.80	5.91	6.23
935.T3.0150.010.100	1.5	1.42	0.10	0.40	10.0	4.0	50	3	10.67	10.88	11.09	11.52	12.48
935.T3.0150.010.150	1.5	1.42	0.10	0.40	15.0	4.0	50	3	15.77	16.05	16.65	17.29	18.73
935.T3.0150.010.200	1.5	1.42	0.10	0.40	20.0	4.0	50	3	20.87	21.41	22.20	23.06	-
935.T3.0150.015.025	1.5	1.42	0.15	0.45	2.5	4.0	50	3	2.95	3.05	3.13	3.21	3.34
935.T3.0150.015.050	1.5	1.42	0.15	0.45	5.0	4.0	50	3	5.53	5.68	5.80	5.91	6.23
935.T3.0150.015.100	1.5	1.42	0.15	0.45	10.0	4.0	50	3	10.67	10.88	11.09	11.52	12.48
935.T3.0150.015.150	1.5	1.42	0.15	0.45	15.0	4.0	50	3	15.77	16.05	16.65	17.29	18.73
935.T3.0150.015.200	1.5	1.42	0.15	0.45	20.0	4.0	50	3	20.87	21.41	22.20	23.06	-
935.T3.0150.020.025	1.5	1.42	0.20	0.50	2.5	4.0	50	3	2.95	3.04	3.13	3.20	3.34
935.T3.0150.020.050	1.5	1.42	0.20	0.50	5.0	4.0	50	3	5.53	5.68	5.80	5.90	6.22
935.T3.0150.020.100	1.5	1.42	0.20	0.50	10.0	4.0	50	3	10.66	10.88	11.09	11.52	12.47
935.T3.0150.020.150	1.5	1.42	0.20	0.50	15.0	4.0	50	3	15.77	16.05	16.65	17.29	18.72
935.T3.0150.020.200	1.5	1.42	0.20	0.50	20.0	4.0	60	3	20.87	21.41	22.20	23.05	-

*DE, AT, CH, LIE, CZ, FR, GB, IT, NL, PL, PT, TR

continued on next page...

($\emptyset 1,57 \pm 0,02$)



935.T3.0150.015.025

IGUANA 935.T3 SERIES...CONTINUED

Article No.	d1	d2	r	l1	l2	d	l	z	Inclination Angle				
									30'	1°	1° 30'	2°	3°
935.T3.0200.010.030	2.0	1.92	0.10	0.40	3.0	4.0	50	3	3.47	3.58	3.67	3.76	3.91
935.T3.0200.010.060	2.0	1.92	0.10	0.40	6.0	4.0	50	3	6.56	6.73	6.86	6.90	7.48
935.T3.0200.010.120	2.0	1.92	0.10	0.40	12.0	4.0	50	3	12.71	12.84	13.32	13.83	14.98
935.T3.0200.010.180	2.0	1.92	0.10	0.40	18.0	4.0	50	3	18.83	19.27	19.98	20.75	-
935.T3.0200.010.240	2.0	1.92	0.10	0.40	24.0	4.0	70	3	24.93	25.70	26.65	27.67	-
935.T3.0200.010.300	2.0	1.92	0.10	0.40	30.0	4.0	70	3	31.02	32.13	33.32	-	-
935.T3.0200.020.030	2.0	1.92	0.20	0.50	3.0	4.0	50	3	3.47	3.57	3.66	3.75	3.89
935.T3.0200.020.060	2.0	1.92	0.20	0.50	6.0	4.0	50	3	6.56	6.72	6.86	6.90	7.47
935.T3.0200.020.120	2.0	1.92	0.20	0.50	12.0	4.0	50	3	12.71	12.84	13.31	13.82	14.97
935.T3.0200.020.180	2.0	1.92	0.20	0.50	18.0	4.0	50	3	18.83	19.27	19.98	20.75	-
935.T3.0200.020.240	2.0	1.92	0.20	0.50	24.0	4.0	70	3	24.93	25.70	26.65	27.67	-
935.T3.0200.020.300	2.0	1.92	0.20	0.50	30.0	4.0	70	3	31.02	32.13	33.31	-	-
935.T3.0200.030.030	2.0	1.92	0.30	0.60	3.0	4.0	50	3	3.47	3.57	3.66	3.75	3.89
935.T3.0200.030.060	2.0	1.92	0.30	0.60	6.0	4.0	50	3	6.56	6.72	6.68	6.90	7.47
935.T3.0200.030.120	2.0	1.92	0.30	0.60	12.0	4.0	50	3	12.71	12.84	13.31	13.82	14.97
935.T3.0200.030.180	2.0	1.92	0.30	0.60	18.0	4.0	50	3	18.83	19.27	19.98	20.74	-
935.T3.0200.030.240	2.0	1.92	0.30	0.60	24.0	4.0	70	3	24.93	25.69	26.64	27.67	-
935.T3.0200.030.300	2.0	1.92	0.30	0.60	30.0	4.0	70	3	31.02	32.12	33.31	-	-
935.T3.0200.050.030	2.0	1.92	0.50	0.80	3.0	4.0	50	3	3.46	3.56	3.64	3.72	3.86
935.T3.0200.050.060	2.0	1.92	0.50	0.80	6.0	4.0	50	3	6.55	6.71	6.84	6.89	7.46
935.T3.0200.050.120	2.0	1.92	0.50	0.80	12.0	4.0	50	3	12.70	12.93	13.31	13.81	14.96
935.T3.0200.050.180	2.0	1.92	0.50	0.80	18.0	4.0	50	3	18.82	19.26	19.97	20.74	-
935.T3.0200.050.240	2.0	1.92	0.50	0.80	24.0	4.0	70	3	24.93	25.69	26.64	27.66	-
935.T3.0200.050.300	2.0	1.92	0.50	0.80	30.0	4.0	70	3	31.02	32.12	33.31	-	-
935.T3.0300.010.060	3.0	2.82	0.10	0.40	6.0	4.0	60	3	6.71	6.85	6.70	6.95	7.53
935.T3.0300.010.090	3.0	2.82	0.10	0.40	9.0	4.0	60	3	9.77	9.68	10.03	10.42	-
935.T3.0300.010.180	3.0	2.82	0.10	0.40	18.0	4.0	60	3	18.94	19.32	20.03	-	-
935.T3.0300.010.240	3.0	2.82	0.10	0.40	24.0	4.0	60	3	24.86	25.75	-	-	-
935.T3.0300.020.060	3.0	2.82	0.20	0.50	6.0	4.0	60	3	6.71	6.84	6.70	6.95	7.52
935.T3.0300.020.090	3.0	2.82	0.20	0.50	9.0	4.0	60	3	9.77	9.67	10.03	10.41	-
935.T3.0300.020.180	3.0	2.82	0.20	0.50	18.0	4.0	60	3	18.94	19.32	20.03	-	-
935.T3.0300.020.240	3.0	2.82	0.20	0.50	24.0	4.0	60	3	24.86	25.75	-	-	-
935.T3.0300.030.060	3.0	2.82	0.30	0.60	6.0	4.0	60	3	6.70	6.84	6.69	6.95	7.52
935.T3.0300.030.090	3.0	2.82	0.30	0.60	9.0	4.0	60	3	9.77	9.94	10.03	10.40	-
935.T3.0300.030.180	3.0	2.82	0.30	0.60	18.0	4.0	60	3	18.93	19.32	20.03	-	-
935.T3.0300.030.240	3.0	2.82	0.30	0.60	24.0	4.0	60	3	24.86	25.74	-	-	-
935.T3.0300.050.060	3.0	2.82	0.50	0.80	6.0	4.0	60	3	6.70	6.83	6.69	6.94	7.51
935.T3.0300.050.090	3.0	2.82	0.50	0.80	9.0	4.0	60	3	9.76	9.94	10.02	10.40	-
935.T3.0300.050.180	3.0	2.82	0.50	0.80	18.0	4.0	60	3	18.93	19.31	20.02	-	-
935.T3.0300.050.240	3.0	2.82	0.50	0.80	24.0	4.0	60	3	24.86	25.74	-	-	-

continued on next page...

Einzelheit A

IGUANA
LASER SERIES

($\emptyset 1,57 \pm 0,02$)

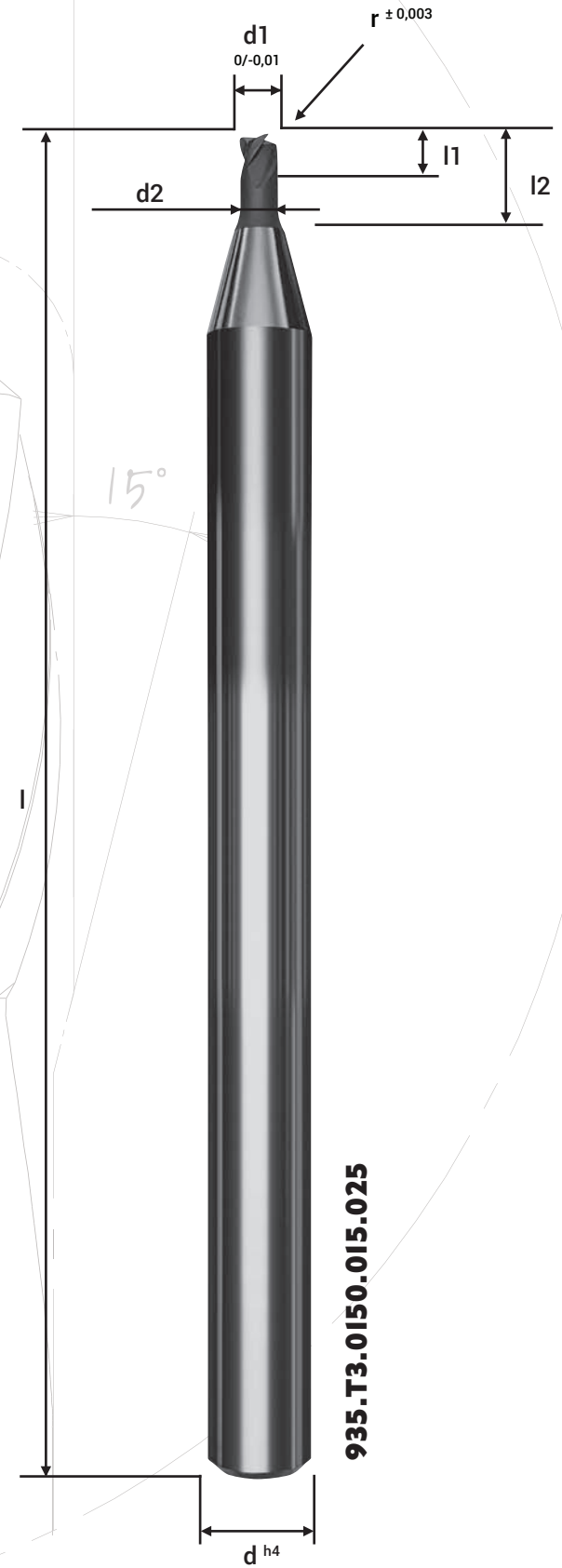

IGUANA 935.T3 SERIES...CONTINUED

Article No.	d1	d2	r	l1	l2	d	l	z	Inclination Angle				
									30'	1°	1° 30'	2°	3°
935.T3.0400.020.080	4.0	3.82	0.20	0.70	8.0	6.0	60	3	8.75	8.91	8.92	9.26	10.02
935.T3.0400.020.120	4.0	3.82	0.20	0.70	12.0	6.0	60	3	12.83	12.89	13.36	13.87	15.02
935.T3.0400.020.240	4.0	3.82	0.20	0.70	24.0	6.0	60	3	24.86	25.75	26.70	27.72	-
935.T3.0400.030.080	4.0	3.82	0.30	0.80	8.0	6.0	60	3	8.75	8.91	8.92	9.26	10.02
935.T3.0400.030.120	4.0	3.82	0.30	0.80	12.0	6.0	60	3	12.83	12.89	13.36	13.87	15.02
935.T3.0400.030.240	4.0	3.82	0.30	0.80	24.0	6.0	60	3	24.86	25.74	26.69	27.72	-
935.T3.0400.050.080	4.0	3.82	0.50	1.00	8.0	6.0	60	3	8.74	8.90	8.91	9.25	10.01
935.T3.0400.050.120	4.0	3.82	0.50	1.00	12.0	6.0	60	3	12.82	12.88	13.36	13.86	15.01
935.T3.0400.050.240	4.0	3.82	0.50	1.00	24.0	6.0	60	3	24.86	25.74	26.69	27.71	-
935.T3.0500.030.080	5.0	4.82	0.30	0.80	8.0	6.0	60	3	8.75	8.91	8.92	9.26	10.02
935.T3.0500.030.150	5.0	4.82	0.30	0.80	15.0	6.0	60	3	15.88	16.10	16.69	-	-
935.T3.0500.030.250	5.0	4.82	0.30	0.80	25.0	6.0	60	3	25.89	26.82	-	-	-
935.T3.0500.050.080	5.0	4.82	0.50	1.00	8.0	6.0	60	3	8.74	8.90	8.91	9.25	10.01
935.T3.0500.050.150	5.0	4.82	0.50	1.00	15.0	6.0	60	3	15.88	16.10	16.69	-	-
935.T3.0500.050.250	5.0	4.82	0.50	1.00	25.0	6.0	60	3	25.89	26.81	-	-	-
935.T3.0600.020.100	6.0	5.82	0.20	0.70	10.0	6.0	60	3	-	-	-	-	-
935.T3.0600.020.180	6.0	5.82	0.20	0.70	18.0	6.0	60	3	-	-	-	-	-
935.T3.0600.020.300	6.0	5.82	0.20	0.70	30.0	6.0	60	3	-	-	-	-	-
935.T3.0600.030.100	6.0	5.82	0.30	0.80	10.0	6.0	60	3	-	-	-	-	-
935.T3.0600.030.180	6.0	5.82	0.30	0.80	18.0	6.0	60	3	-	-	-	-	-
935.T3.0600.030.300	6.0	5.82	0.30	0.80	30.0	6.0	60	3	-	-	-	-	-
935.T3.0600.050.100	6.0	5.82	0.50	1.00	10.0	6.0	60	3	-	-	-	-	-
935.T3.0600.050.180	6.0	5.82	0.50	1.00	18.0	6.0	60	3	-	-	-	-	-
935.T3.0600.050.300	6.0	5.82	0.50	1.00	30.0	6.0	60	3	-	-	-	-	-

Einzelheit A

IGUANA
LASER SERIES

($\emptyset 1,57 \pm 0,02$)

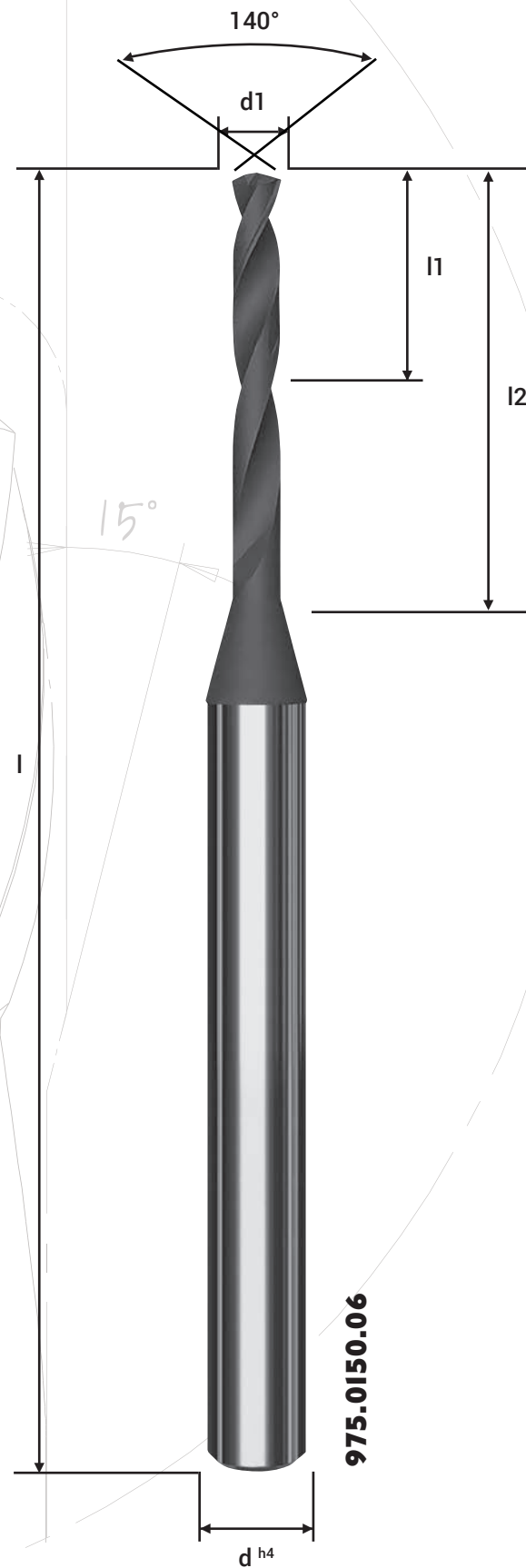

IGUANA 975 SERIES

- 2-flute twist drill and 30° angled flutes
- One-sided laser-sharpened Diamond Coating
- For wet drilling of non-ferrous metals
- Neck extension or reduction of the total length upon request

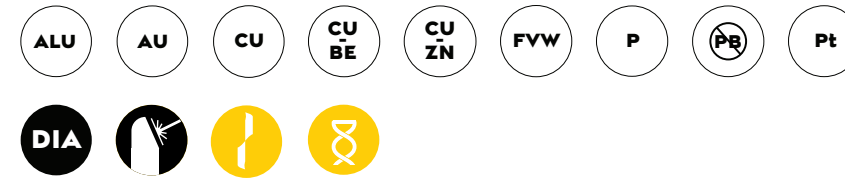

Article No.	d1	l1	l4	d	l
975.0080.06	0.8	6.5	6.8	3.0	38
975.0090.06	0.9	7.0	7.3	3.0	38
975.0100.06	1.0	9.0	9.3	3.0	38
975.0110.06	1.1	9.0	9.3	3.0	38
975.0120.06	1.2	10.0	10.3	3.0	38
975.0130.06	1.3	10.0	10.3	3.0	38
975.0140.06	1.4	11.5	11.8	3.0	38
975.0150.06	1.5	12.0	12.3	3.0	38
975.0160.06	1.6	12.0	12.3	3.0	38
975.0170.06	1.7	12.0	12.3	3.0	38
975.0180.06	1.8	12.0	12.3	3.0	38
975.0190.06	1.9	12.0	12.3	3.0	38
975.0200.06	2.0	12.0	12.3	3.0	38

(Ø 1,57 ±0,02)

SERIES OVERVIEW

The IGUANA LASER SERIES has several variations, which we break down below. Here you will find a brief explanation of the tool series as well as relevant symbols for the properties of the tools. More information about the series and a legend to the symbols can be found on the following pages.

Serie	Geeignete Materialien									Suitable Machining Processes						Blank material / Coating			Tool design									
	Aluminum	Brass	Brass (Lead-Free)	Copper	Copper-Beryllium	Fiber-Reinforced Materials	Gold	Plastic	Platinum	Drilling	Roughing	Pre-Finishing	Finishing	HSC	Dry	Wet	DIA	One-Sided Laser Sharpened	Two Sided Laser Sharpened	Geometry	Flutes	Center cut	Angled Flutes	Helix Flutes	Internal cooling	Patented Design	Measurement protocol	
902	xx ¹	xx	xx	xx	xx	xx	xx	xx	xx				x	x	x	x	x		x	Ball	2	x	x					x
903	xx	xx	xx	xx	xx	xx	xx	xx	xx				x	x	x	x	x	x		Ball	2	x	x					x
912	xx	xx	xx	xx	xx	xx	xx	xx	xx				x	x	x	x	x		x	Toric	2		x					x
913	xx	xx	xx	xx	xx	xx	xx	xx	xx				x	x	x	x	x	x		Toric	2		x					x
915	xx	xx	xx	xx	xx	xx	xx	xx	xx				x	x	x	x	x		x	Flat	3		x					x
916	xx	xx	xx	xx	xx	xx	xx	xx	xx				x	x	x	x	x	x		Flat	3		x					x
918	xx	xx	xx	xx	xx	xx	xx	xx	xx				x	x	x	x	x		x	Flat	3	x	x		x			x
930.B2	xx	xx	xx	xx	xx	xx	xx	xx	xx				x	x	x	x	x	x		Ball	2	x		x				x
930.T2	xx	xx	xx	xx	xx	xx	xx	xx	xx				x	x	x	x	x	x		Toric	2			x				x
930.F3	xx	xx	xx	xx	xx	xx	xx	xx	xx				x	x	x	x	x	x		Flat	3			x				x
931.T3	xx	xx	xx	xx	xx	xx	xx	xx	xx				x	x	x	x	x	x		Toric	3	x		x	x			x
935.B2	xx	xx	xx	xx	xx	xx	xx	xx	xx				x	x	x	x	x	x		Ball	2	x		x		x		x
935.T2	xx	xx	xx	xx	xx	xx	xx	xx	xx				x	x	x	x	x	x		Toric	2			x		x		x
935.T3	xx	xx	xx	xx	xx	xx	xx	xx	xx				x	x	x	x	x	x		Toric	3	x		x		x		x
975	xx	xx	xx	xx	xx	xx	xx	xx	xx						x	x	x	x		Twist Drill	2			x				x

¹ „xx“ indicates that it is optimally designed for processing this material, „x“ indicates that it also works in this material.

IGUANA LASER SERIES

(Ø 1,57 ±0,02)

ICON LEGEND

- White background symbols represent Primary Recommended Materials
- Symbols to represent tool coating

- Symbols to represent the tool design properties
- Symbols to represent the indication types of the tool

ICONS

Material Icons

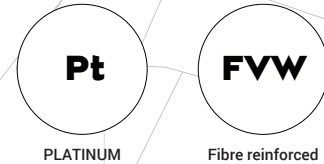
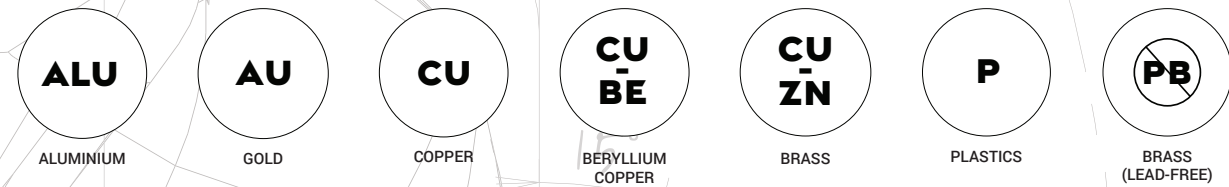

Symbols for the coating or material of the flute/coating

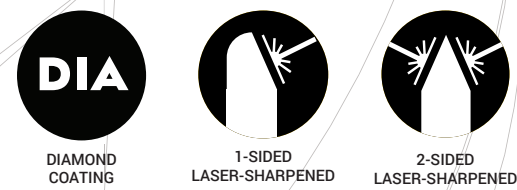

Tool properties

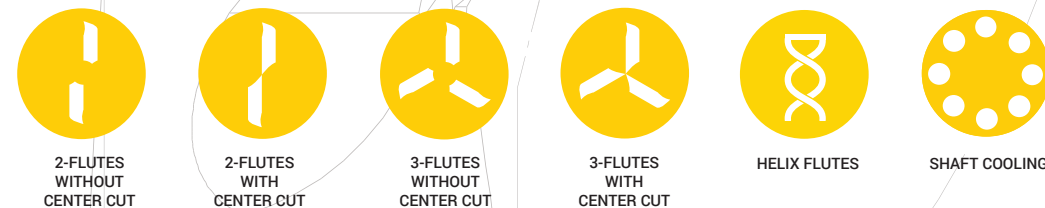

Recommended use

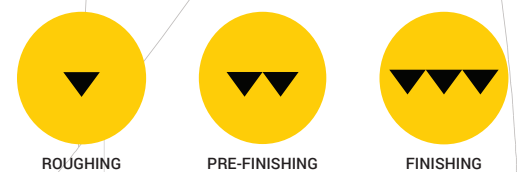

FURTHER INFO

Safety instructions:

- wet machining is recommended for optimum machining results with our cutters and drills; dry machining is only suitable under certain conditions.
- keep the temperature low during use of our cutters and drills by constant cooling to ensure performance and safety.
- always follow the specific application recommendations for our milling cutters and drills per series to ensure optimum results and safety.
- high concentricity of the machine is essential for the safe and efficient use of our cutters and drills.

AWARD-WINNING: AWARDS FOR OUTSTANDING PERFORMANCE

Only with motivated, positive thinking and independent personalities can a company exist and grow together on new challenges. ZECHA is proud of all its employees for their tireless commitment, passion for progress and willingness to actively contribute to innovation. The awards are the result of creative collaboration and a tribute to the industry.



INNOVATION AWARD OF THE STATE OF BADEN-WÜRTTEMBERG

In 2021, ZECHA Hartmetall-Werkzeugfabrikation GmbH was awarded the Innovation Prize of the State of Baden-Württemberg for the first time. The prize was awarded for the development of a tool family with diamond-coated micro-precision tools that offer outstanding performance in machining the most demanding materials with smooth surfaces. These achievements set new standards worldwide in the field of precision tools.



TOP 100-AWARD

With its outstanding innovation management, ZECHA Hartmetall-Werkzeugfabrikation GmbH receives the TOP 100 seal 2023, an award that is only given to particularly innovative medium-sized companies. The competition is based on a scientific selection process. The decisive factor is whether a company's innovations are random or systematically planned and will be repeatable in the future.

IGUANA
LASER SERIES

(\varnothing 1,57 \pm 0,02)



ZECHA

außergewöhnlich.

THE NEW ZECHA BRANDING

Over the years, brands consistently evolve and transform to meet the changing needs and preferences of their consumers. In the competitive landscape of 2023, ZECHA is poised to introduce its new brand identity, marking a significant milestone in its journey. The unveiling of the ZECHA branding represents a culmination of the brand's growth and commitment to excellence.

At the core of the new ZECHA logo lies a perfect circle, which symbolizes the meticulous process of the first step in the process of making all tools at ZECHA, which is grinding tools into flawless cylinders. This iconic image embodies ZECHA's

dedication to precision and quality. It signifies the brand's unwavering pursuit of perfection, ensuring that every tool manufactured by ZECHA is perfectly concentric, guaranteeing superior performance.

In the new branding, ZECHA also integrates the word "außergewöhnlich" into various visuals. Derived from the German language, "außergewöhnlich" translates to "extraordinary" in English. This carefully chosen word encapsulates the overarching goal of every product created by ZECHA. It signifies the brand's commitment to delivering exceptional tools that surpass expectations and set new standards within the industry.

The ZECHA Logo through the years:



Ø 2,02 ±0,02

(Ø 1,57 ±0,02)

TOP
100

top100.de

Top-Innovator
2023

ZECHA'S COMMITMENT TO EXCELLENCE

OVER HALF A CENTURY OF PRECISION

ZECHA Hartmetall-Werkzeugfabrikation GmbH is a precision tool manufacturer that has been in Baden-Württemberg, Germany for nearly 60 years. With a focus on manufacturing high quality micro tools, we pride ourselves on providing our customers with the highest level of precision and consistency in our products. Our state-of-the-art manufacturing and measurement technologies allow us to maintain the highest quality standards and ensure that our tools meet our customers' needs.

With a focus on innovation and the constant research of new technologies, we improve the precision and efficiency of our tools. This philosophy allows us to stay at the forefront of the industry and provide our customers with state-of-the-art solutions for their tooling needs.

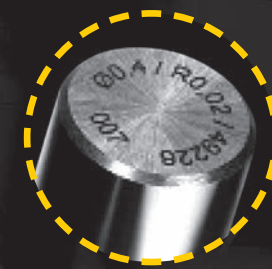
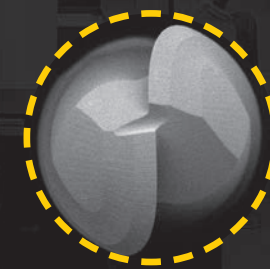



zeit A



ZECHA
außergewöhnlich.

IGUANA

LASER SERIES

(\emptyset 1,57 \pm 0,02)

15°



ZECA Hartmetall-Werkzeugfabrikation GmbH
Benzstraße 2, D-75203 Königsbach-Stein
+49 7232 3022 0
www.zecha.de, info@zecha.de

