

KINGFISHER
SERIES

außergewöhnlich.

COOL.

$\varnothing 1 \pm 0.001^{\circ}$

0.95



Z ZECHA



ZECHA
außergewöhnlich.

KINGFISHER SERIES



KINGFISHER SERIES

OPTIMIZED COOLANT FOR SUPERIOR PERFORMANCE

Efficient cooling is vital when working with difficult-to-machine materials such as titanium, stainless steel, non-ferrous, and precious metals.

The innovative cooling solutions in the KINGFISHER SERIES minimize the risk of material adhesion to the tool and promote effective chip evacuation through full track grooves.

Additionally, the „cold shock effect“ on the chips facilitates chip breaking, further improving machining efficiency.

By reducing tool wear and conserving resources, the KINGFISHER SERIES not only enhances tool life but also boosts overall productivity, making it an indispensable asset for precision machining.

KINGFISHER SERIES

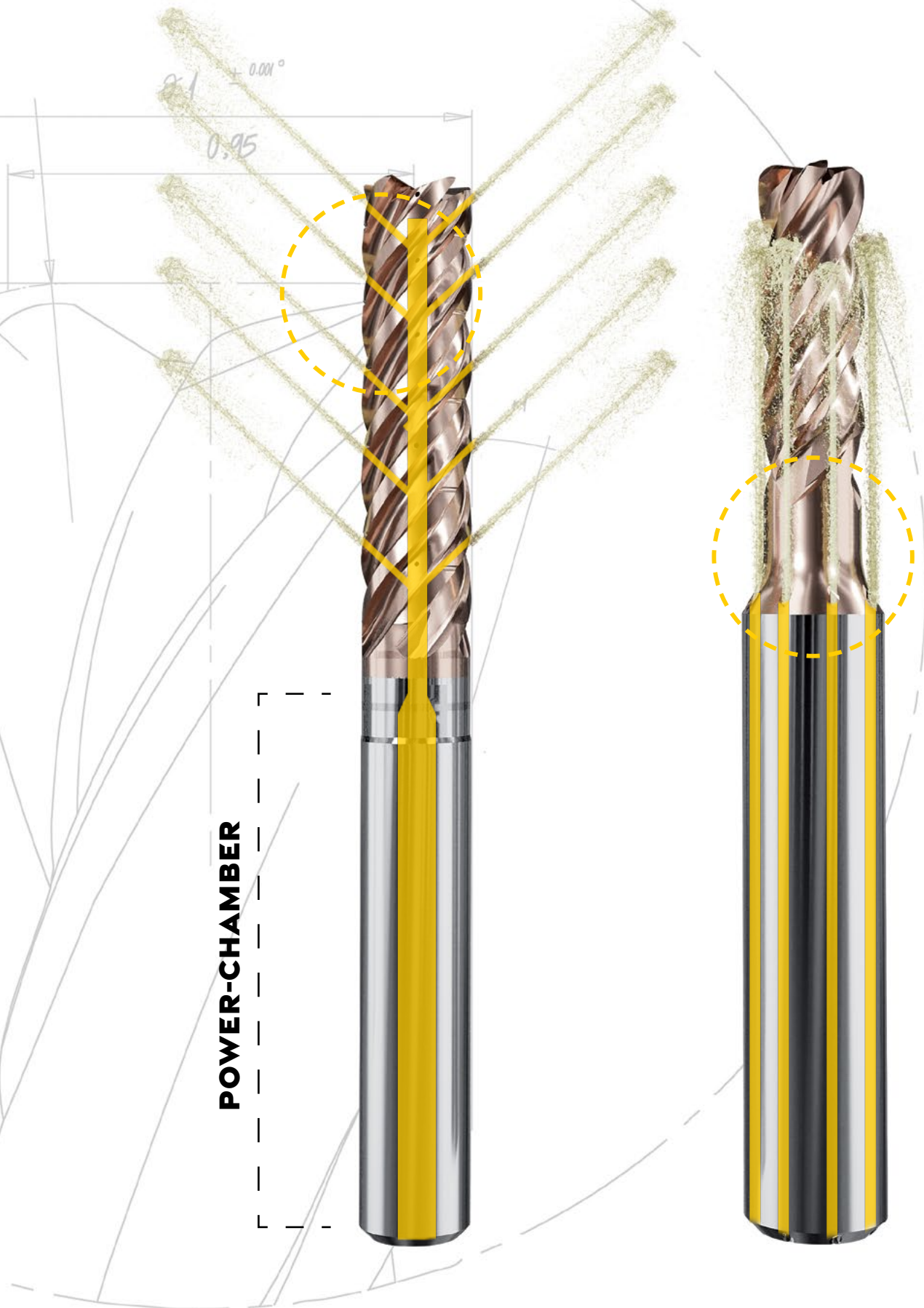

INNOVATIVE COOLANT DELIVERY DESIGN

BRINGING COOLANT EXACTLY
WHERE IT'S NEEDED

The KINGFISHER SERIES is equipped with next-generation cooling systems designed to enhance the efficiency and performance of your machining operations.

These advanced systems include internal and shank coolant channels that deliver coolant directly

to the contact point between the flute and the material.

The additional 'power chamber' design in the tools with internal cooling system increases the coolant pressure and thereby significantly increases the flow rate

KINGFISHER SERIES

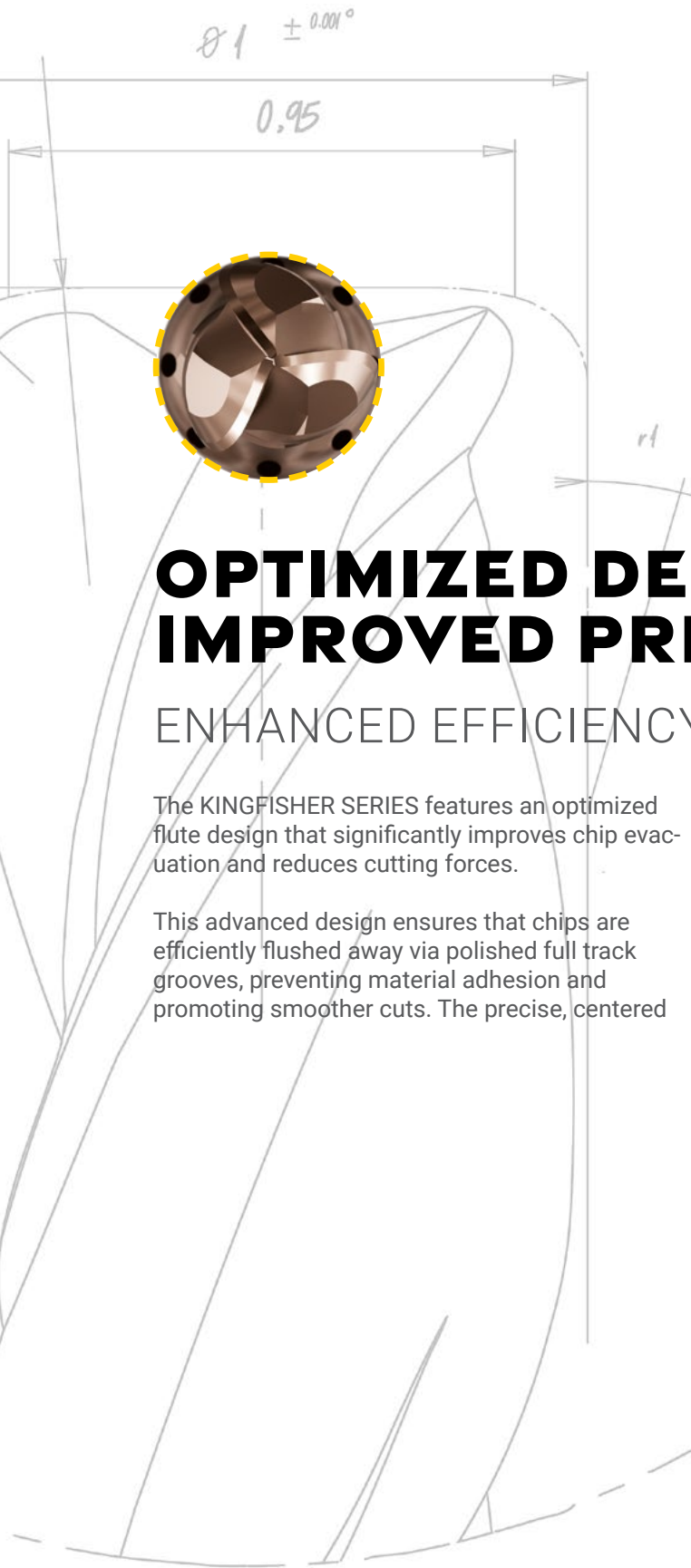

OPTIMIZED DESIGN, IMPROVED PRECISION

ENHANCED EFFICIENCY AND SURFACE QUALITY

The KINGFISHER SERIES features an optimized flute design that significantly improves chip evacuation and reduces cutting forces.

This advanced design ensures that chips are efficiently flushed away via polished full track grooves, preventing material adhesion and promoting smoother cuts. The precise, centered

flutes contribute to dimensional and geometric accuracy, resulting in superior surface finishes.

Whether you are roughing, prefinishing, or finishing, the KINGFISHER SERIES' optimized flute design delivers exceptional performance and reliability.

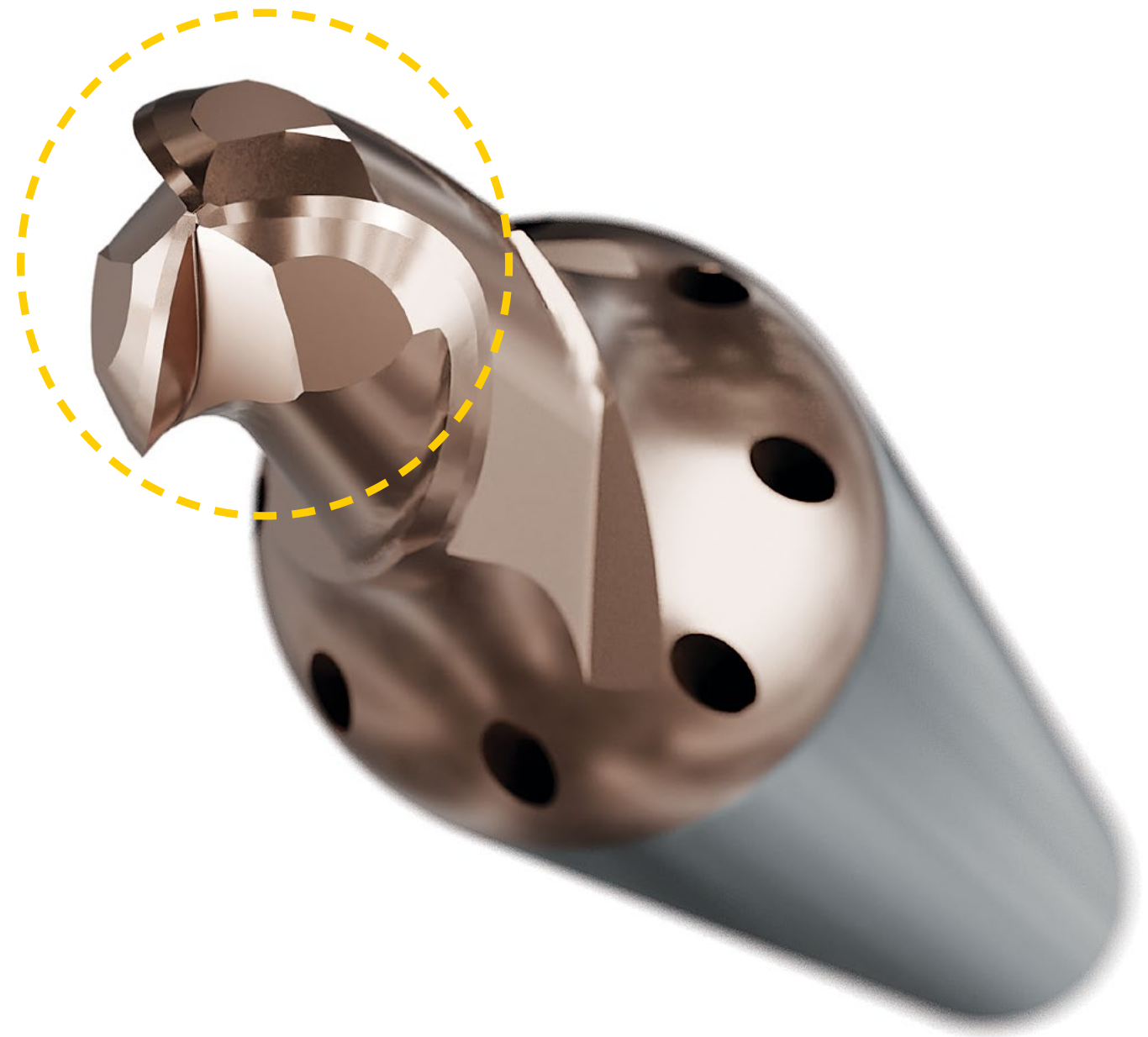

KINGFISHER
SERIES

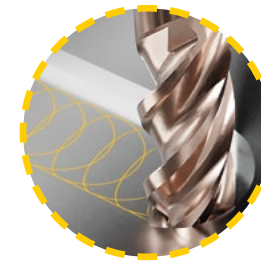
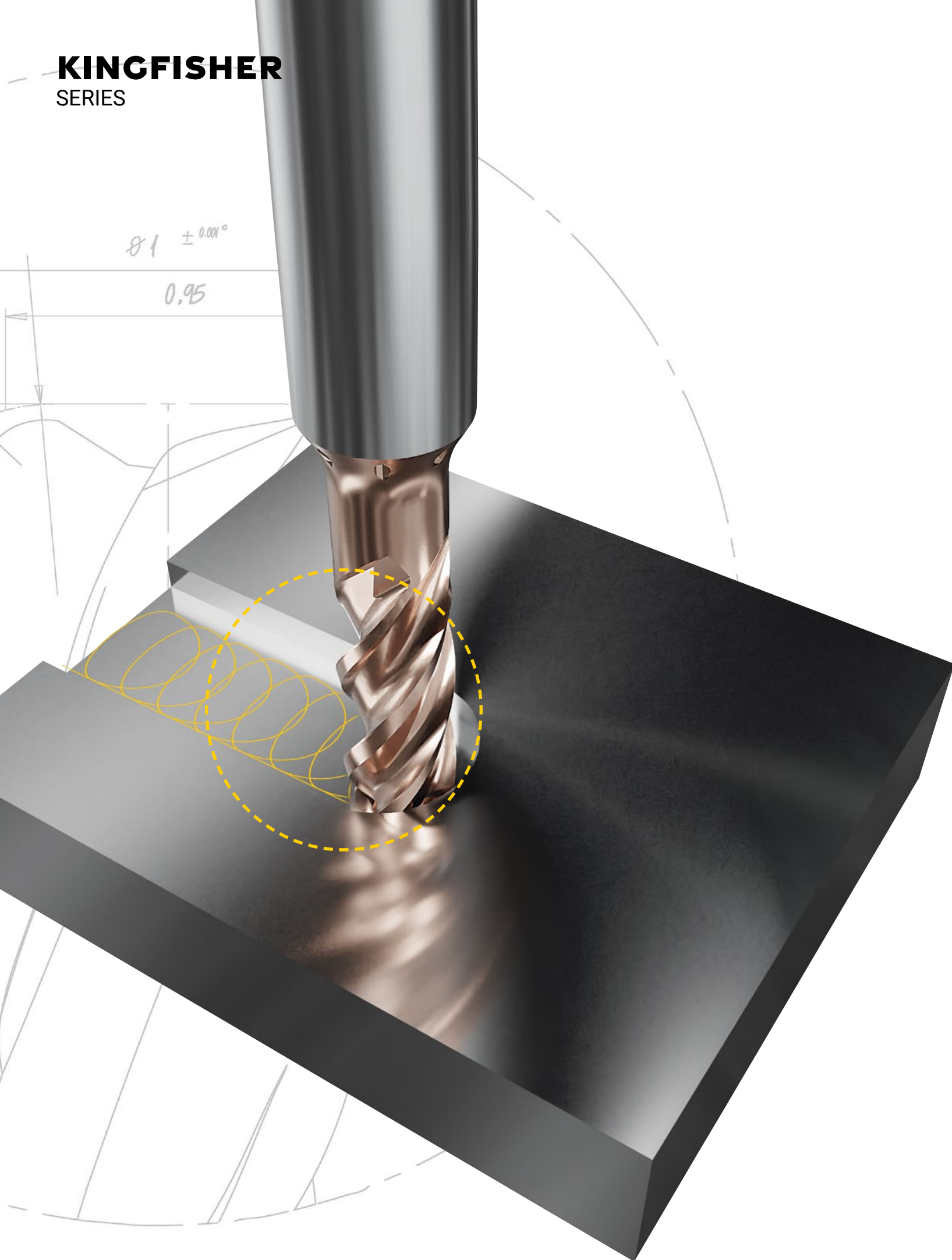

MORE EFFICIENT TROCHOIDAL MILLING

DESIGNED FOR OPTIMAL MACHINING

The KINGFISHER SERIES is specifically designed for efficient trochoidal milling, a technique that maximizes material removal rates while minimizing heat buildup and tool wear.

The advanced geometries and stable cutting edges of KINGFISHER tools enable smooth, consistent engagement with the material, reducing the stress on both the tool and the machine.

This design enhances the overall efficiency of trochoidal milling operations, allowing for faster, more precise machining of difficult-to-machine materials.

KINGFISHER SERIES



SEE IT IN ACTION

MILLING EXAMPLES IN TITANIUM AND STAINLESS STEEL

Would you like to see the KINGFISHER tool technology in action? Scan the QR codes below to access YouTube videos showcasing the precise milling work of KINGFISHER tools in titanium and stainless steel. Experience the effortless precision and efficiency that characterize the KINGFISHER SERIES.



Stainless steel
Demo



Titanium
Demo

KINGFISHER SERIES

SERIES OPTIONS

Numerous variations are available in the KINGFISHER SERIES, which we will break down for you below. Here you will find a brief explanation of the different tool series as well as relevant symbols for the properties of the tools. More information about the series and a key explaining the different symbols can be found on the following pages.

455 SERIES

Solid carbide 3-flute ball-nose end mill with 30° helix angle, HSC (High Speed Cutting) optimized, uncoated.

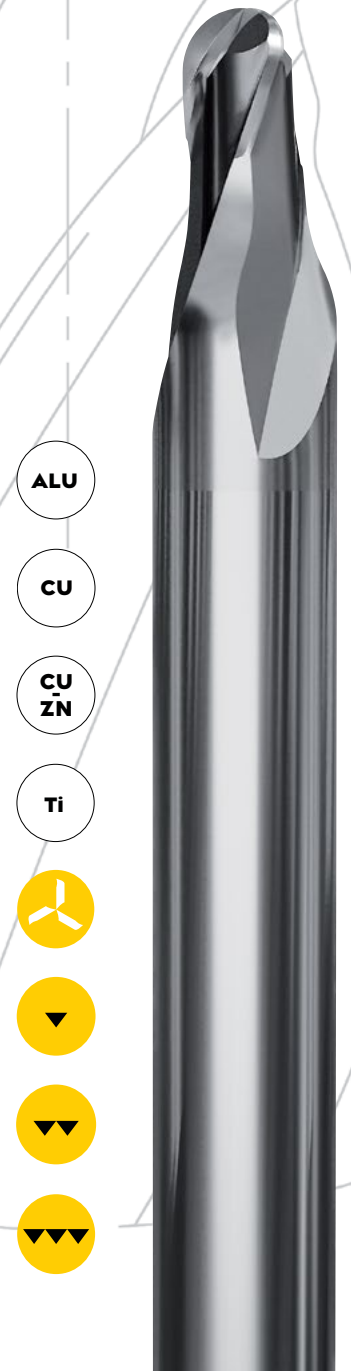

- ALU
- CU
- CU ZN
- Ti
- 3-flute symbol
- 30° helix symbol
- 3-flute symbol
- 3-flute symbol

455M SERIES

Solid carbide 3-flute ball-nose end mill with 30° helix angle, HSC (High Speed Cutting) optimized, thin BCR coating



- BCR
- INOX
- Ti
- CU ZN
- Ni-Cr
- U
- 3-flute symbol
- 30° helix symbol
- 3-flute symbol
- 3-flute symbol

455P SERIES

Solid carbide 3-flute ball-nose end mill with 30° helix angle, HSC (High Speed Cutting) optimized, High-End WAD coating



- INOX
- Ti
- U
- ALU
- CU ZN
- Ni-Cr
- X
- WAD
- 3-flute symbol
- 30° helix symbol
- 3-flute symbol
- 3-flute symbol

455S.B3 SERIES

Solid carbide 3-flute ball-nose end mill with 35° helix angle, HSC (High Speed Cutting) optimized, High-End WAD-coating, shank or internal coolant channels

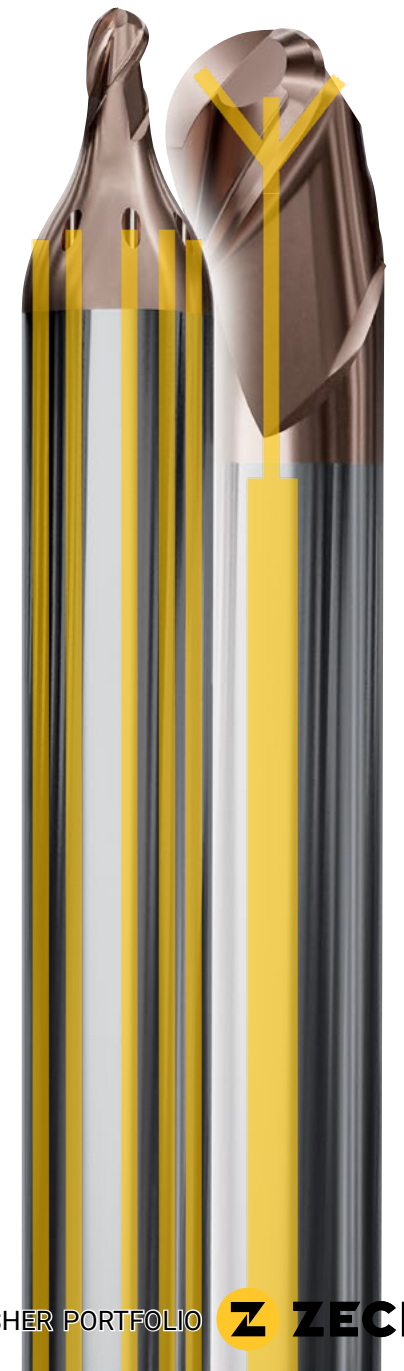

- ALU
- Ti
- U
- CU ZN
- INOX
- Ni-Cr
- X
- WAD
- 3-flute symbol
- 35° helix symbol
- 3-flute symbol
- 3-flute symbol















KINGFISHER SERIES

$\varnothing 1 \pm 0.001^{\circ}$
0.95

455.F3 SERIES

Solid carbide 3-flute end mill with 35° helix angle, HPC (High Performance Cutting) optimized, High-End WAD coating, shank coolant channels













-  WAD
-  ALU
-  Ti
-  U
-  CU ZN
-  INOX
-  Ni-Cr
-  X
-  Ti
-  U
-  CU ZN
-  INOX
-  Ni-Cr
-  X

455.F5 SERIES

Solid carbide 5-flute end mill with 35° helix angle, HPC (High Performance Cutting) optimized, High-End WAD coating, shank or internal coolant channels











-  WAD
-  ALU
-  Ti
-  INOX
-  U
-  CU ZN
-  Ni-Cr
-  X
-  Ti
-  U
-  CU ZN
- INOX
- Ni-Cr
- X

455.T2 SERIES

Solid carbide 2-flute end mill with corner radius, 40° helix angle, HPC (High Performance Cutting) optimized, High-End WAD coating, shank coolant channels



-  WAD
-  ALU
-  Ti
-  INOX
-  U
-  CU ZN
-  Ni-Cr
-  X
-  Ti
-  U
- CU ZN
- INOX
- Ni-Cr
- X

455.T4 SERIES

Solid carbide 4-flute end mill with corner radius, 35/37° helix angle, HPC (High Performance Cutting) optimized, High-End WAD coating, shank or internal coolant channels



-  WAD
-  ALU
-  Ti
-  INOX
-  U
-  CU ZN
-  Ni-Cr
-  X
-  Ti
-  U
-  CU ZN
- INOX
- Ni-Cr
- X

KINGFISHER SERIES

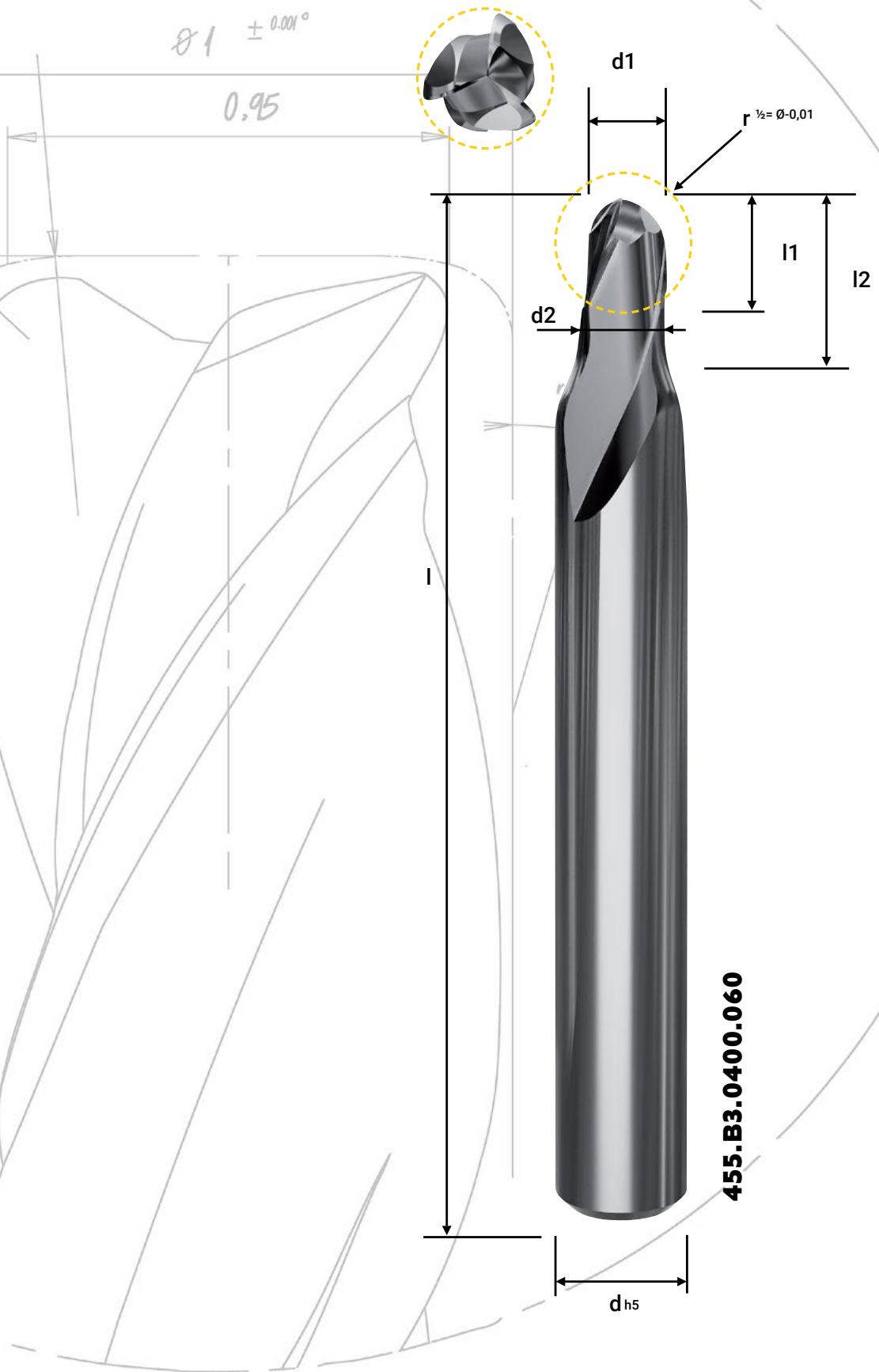

KINGFISHER 455 SERIES

- Solid carbide 3-flute ball-nose end mill with a 30° helix angle
- HSC (High Speed Cutting) optimized
- Uncoated
- For dry or wet roughing/semi-finishing/finishing



Article No.	d1	d2	l1	l2	d	l	Z
455.B3.0200.030	2.0	1.95	2.0	3.0	6.0	45	3
455.B3.0300.045	3.0	2.90	3.0	4.5	6.0	45	3
455.B3.0400.060	4.0	3.90	4.0	6.0	6.0	45	3
455.B3.0500.075	5.0	4.90	5.0	7.5	6.0	45	3
455.B3.0600.090	6.0	5.90	6.0	9.0	6.0	45	3
455.B3.0800.120	8.0	7.90	8.0	12.0	6.0	50	3

KINGFISHER SERIES

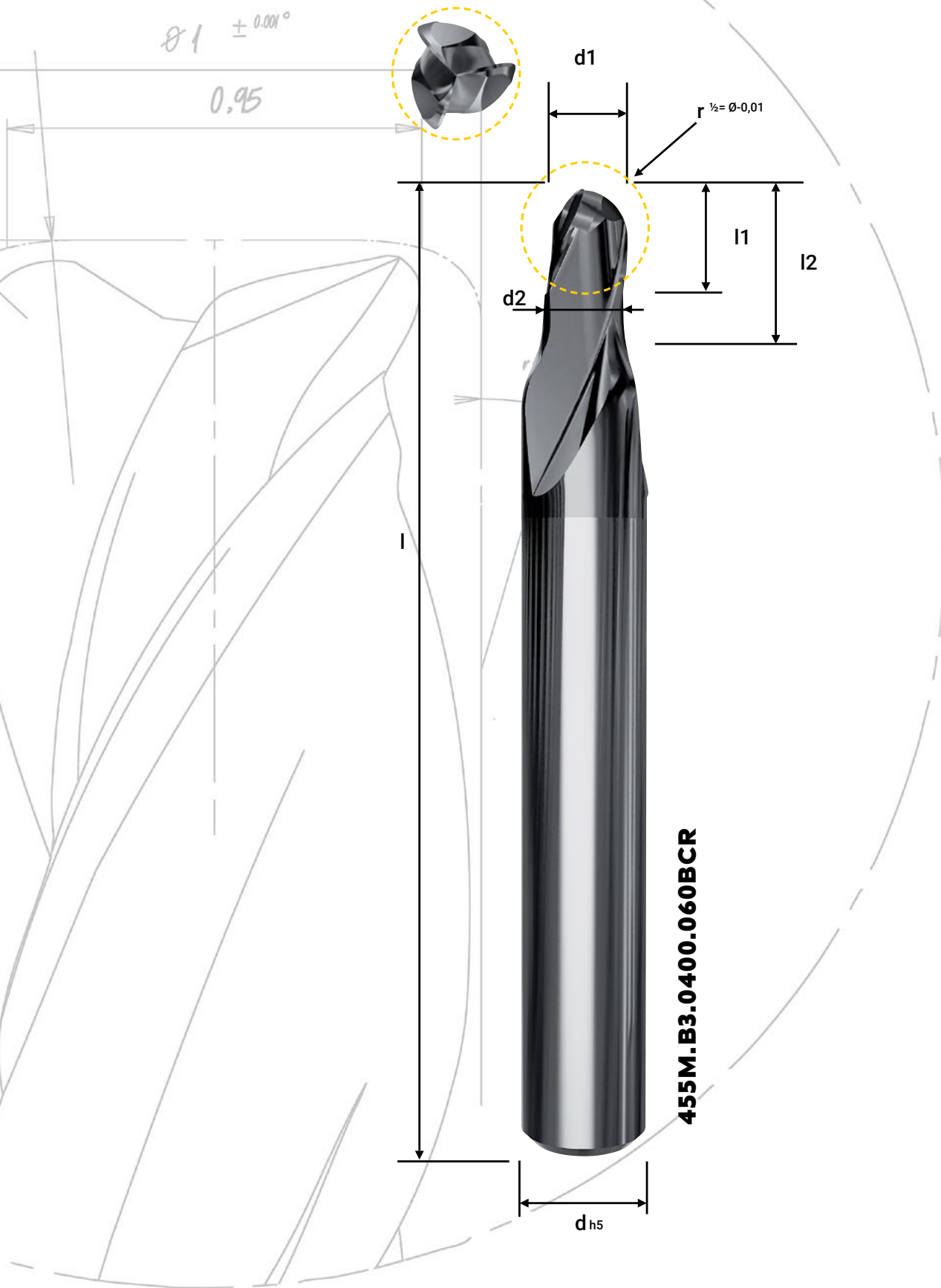

KINGFISHER 455M SERIES

- Solid carbide 3-flute ball-nose end mill with a 30° helix angle
- HSC (High Speed Cutting) optimized
- Thin BCR coating
- For dry or wet roughing/semi-finishing/finishing



Article No.	d1	d2	l1	l2	d	l	Z
455M.B3.0200.030BCR	2.0	1.95	2.0	3.0	6.0	45	3
455M.B3.0300.045BCR	3.0	2.90	3.0	4.5	6.0	45	3
455M.B3.0400.060BCR	4.0	3.90	4.0	6.0	6.0	45	3
455M.B3.0500.075BCR	5.0	4.90	5.0	7.5	6.0	45	3
455M.B3.0600.090BCR	6.0	5.90	6.0	9.0	6.0	45	3
455M.B3.0800.120BCR	8.0	7.90	8.0	12.0	8.0	50	3

KINGFISHER SERIES

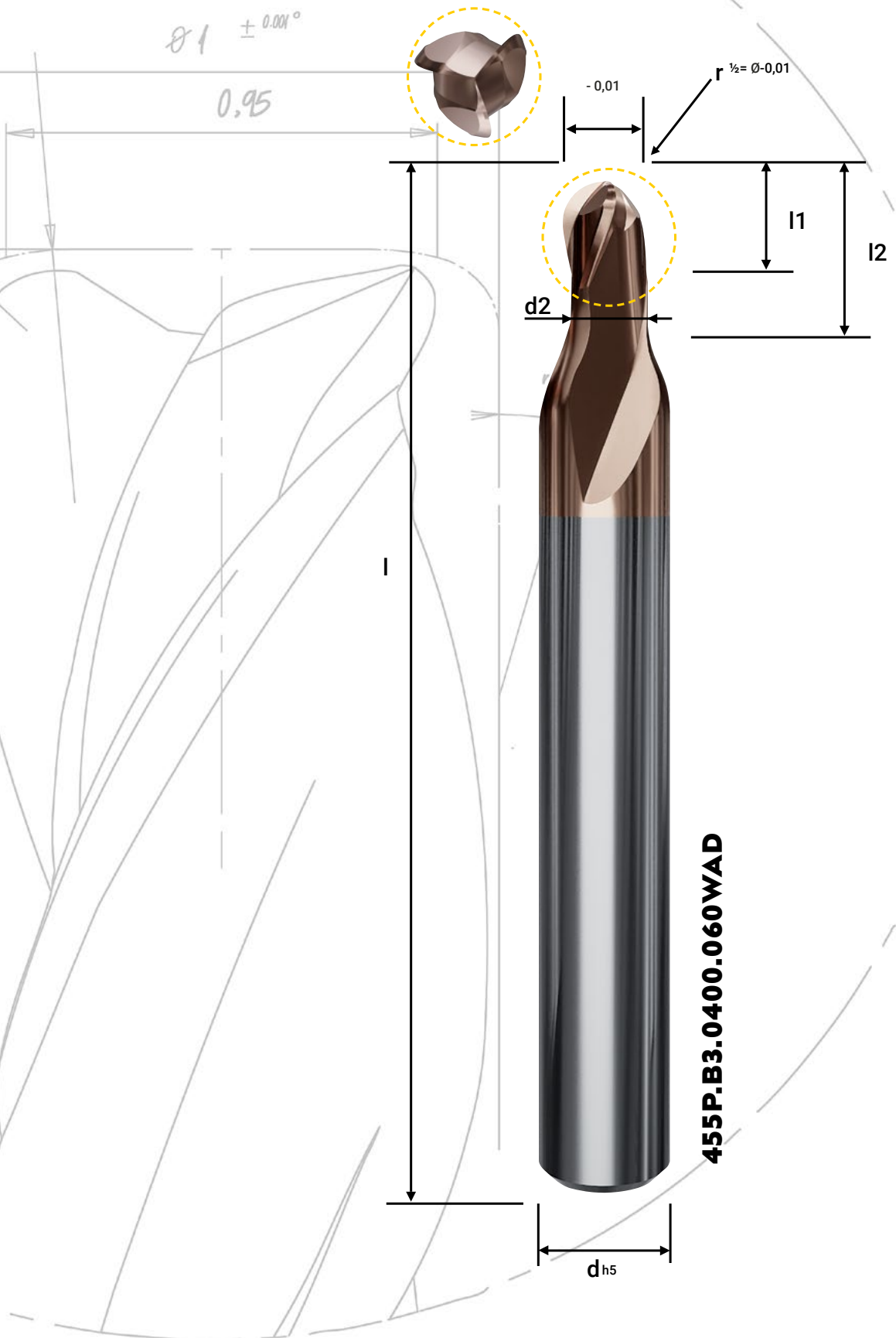

KINGFISHER 455P SERIES

- Solid carbide 3-flute ball-nose end mill with a 30° helix angle
- HSC (High Speed Cutting) optimized
- High-End WAD coating
- For dry or wet roughing/semi-finishing/finishing

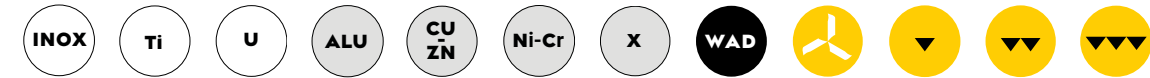

Article No.	d1	d2	l1	l2	d	l	Z
455P.B3.0200.030WAD	2.0	1.95	2.0	3.0	6.0	45	3
455P.B3.0300.045WAD	3.0	2.90	3.0	4.5	6.0	45	3
455P.B3.0400.060WAD	4.0	3.90	4.0	6.0	6.0	45	3
455P.B3.0500.075WAD	5.0	4.90	5.0	7.5	6.0	45	3
455P.B3.0600.090WAD	6.0	5.90	6.0	9.0	6.0	45	3
455P.B3.0800.120WAD	8.0	7.90	8.0	12.0	8.0	50	3

KINGFISHER SERIES

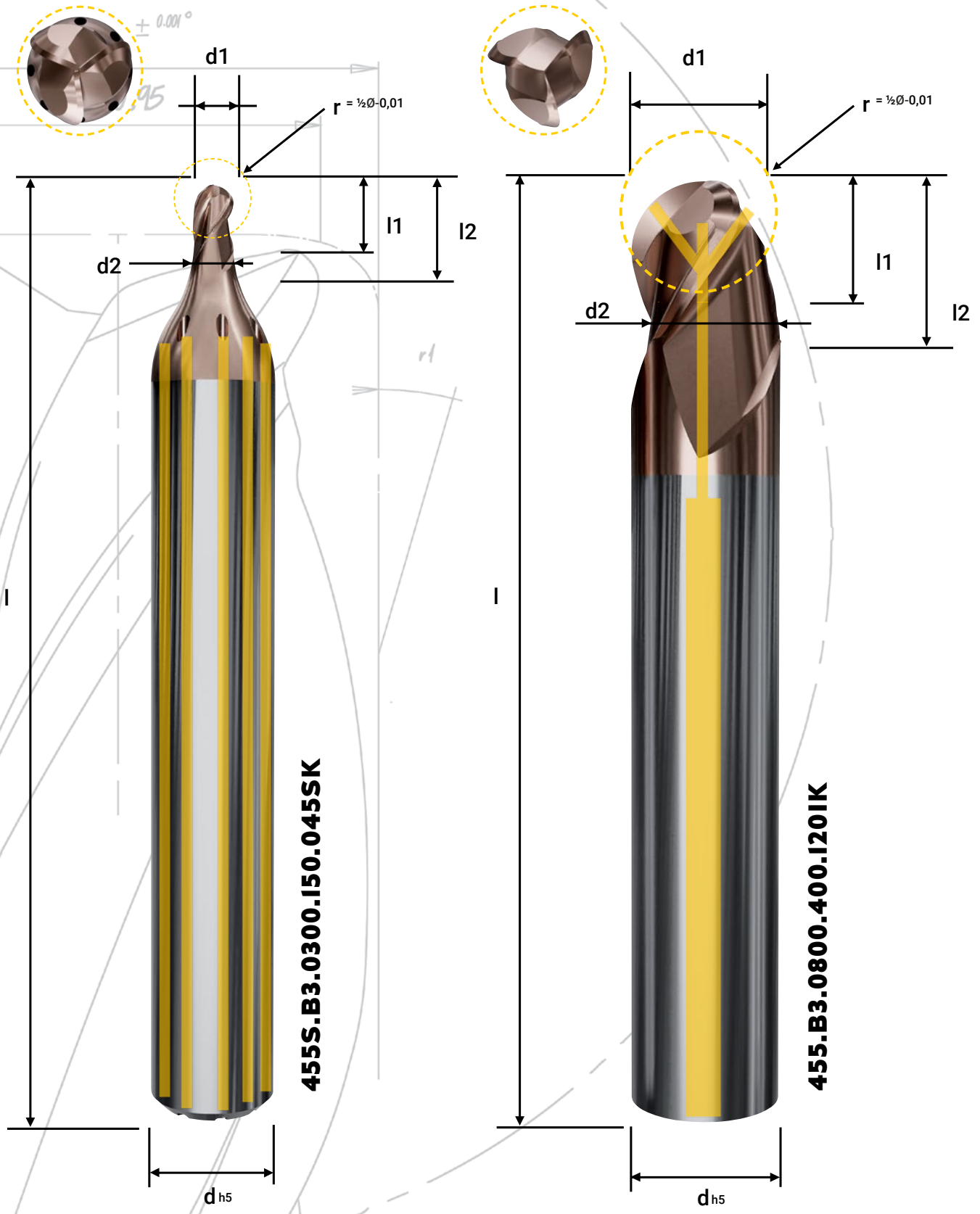

KINGFISHER 455S.B3 SERIES

- Solid carbide 3-flute ball-nose end mill with a 35° helix angle
- HSC (High Speed Cutting) optimized
- High-End WAD coating
- With shank coolant channels
- For dry or wet roughing/semi-finishing/finishing

ALU Ti U CU ZN INOX Ni-Cr X

WAD



Article No.	d1	d2	r	l1	l2	d	l	Z
455S.B3.0150.075.025SK	1.5	1.45	0.75	1.5	2.5	6.0	45	3
455S.B3.0150.075.040SK	1.5	1.45	0.75	1.5	4.0	6.0	45	3
455S.B3.0200.100.040SK	2.0	1.95	1.00	2.0	3.0	6.0	45	3
455S.B3.0300.150.045SK	3.0	2.95	1.50	3.0	4.5	6.0	45	3
455S.B3.0400.200.060SK	4.0	3.90	2.00	4.0	6.0	6.0	45	3
455S.B3.0500.250.075SK	5.0	4.90	2.50	5.0	7.5	8.0	60	3
455S.B3.0600.300.090SK	6.0	5.90	3.00	6.0	9.0	8.0	60	3

- Solid carbide 3-flute ball-nose end mill with a 35° helix angle
- HSC (High Speed Cutting) optimized
- High-End WAD coating
- With internal coolant channels
- For dry or wet roughing/semi-finishing/finishing

ALU Ti U CU ZN INOX Ni-Cr X WAD

Article No.	d1	d2	r	l1	l2	d	l	Z
455S.B3.0800.400.120IK	8.0	7.90	4.00	8.0	12.0	8.0	50	3
455S.B3.1000.500.150IK	10.0	9.80	5.00	10.0	15.0	10.0	60	3

KINGFISHER SERIES

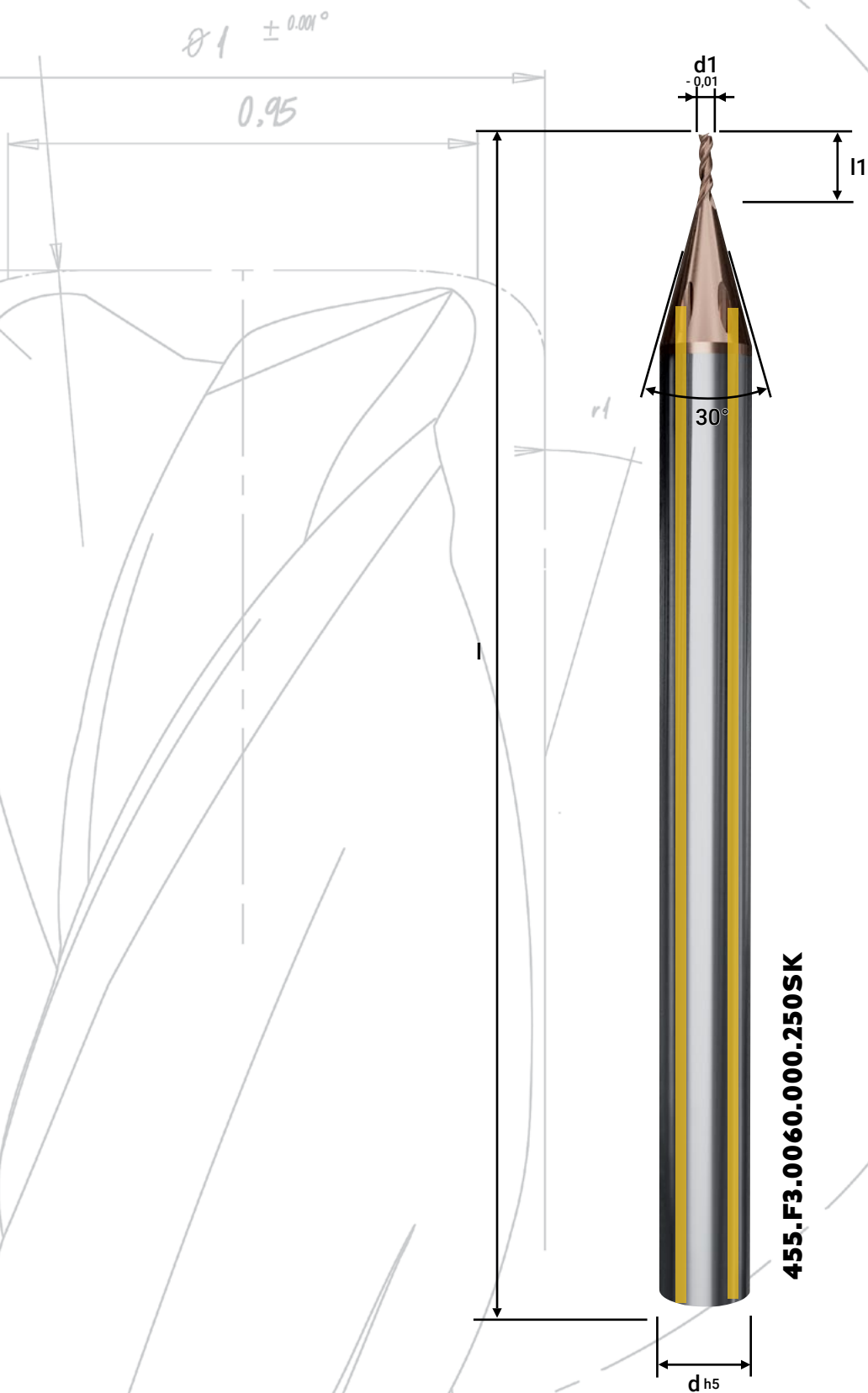

KINGFISHER 455.F3 SERIES

- Solid carbide 3-flute end mill with a 35° helix angle
- HPC (High Performance Cutting) optimized
- High-End WAD coating
- With shank coolant channels
- For dry or wet roughing/semi-finishing/finishing

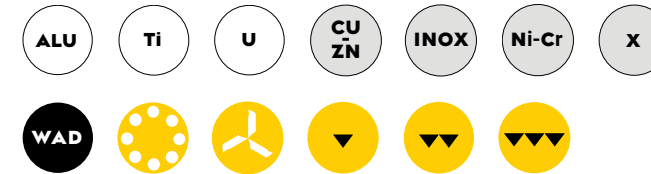

Article No.	d1	l1	d	l	Z
455.F3.0020.000.060SK	0.2	0.6	4.0	40	3
455.F3.0030.000.090SK	0.3	0.9	4.0	40	3
455.F3.0040.000.160SK	0.4	1.6	4.0	40	3
455.F3.0050.000.210SK	0.5	2.1	4.0	40	3
455.F3.0060.000.250SK	0.6	2.5	4.0	40	3
455.F3.0080.000.290SK	0.8	2.9	4.0	40	3
455.F3.0100.000.400SK	1.0	4.0	4.0	40	3
455.F3.0150.000.500SK	1.5	5.0	4.0	40	3
455.F3.0200.000.700SK	2.0	7.0	4.0	40	3

KINGFISHER SERIES

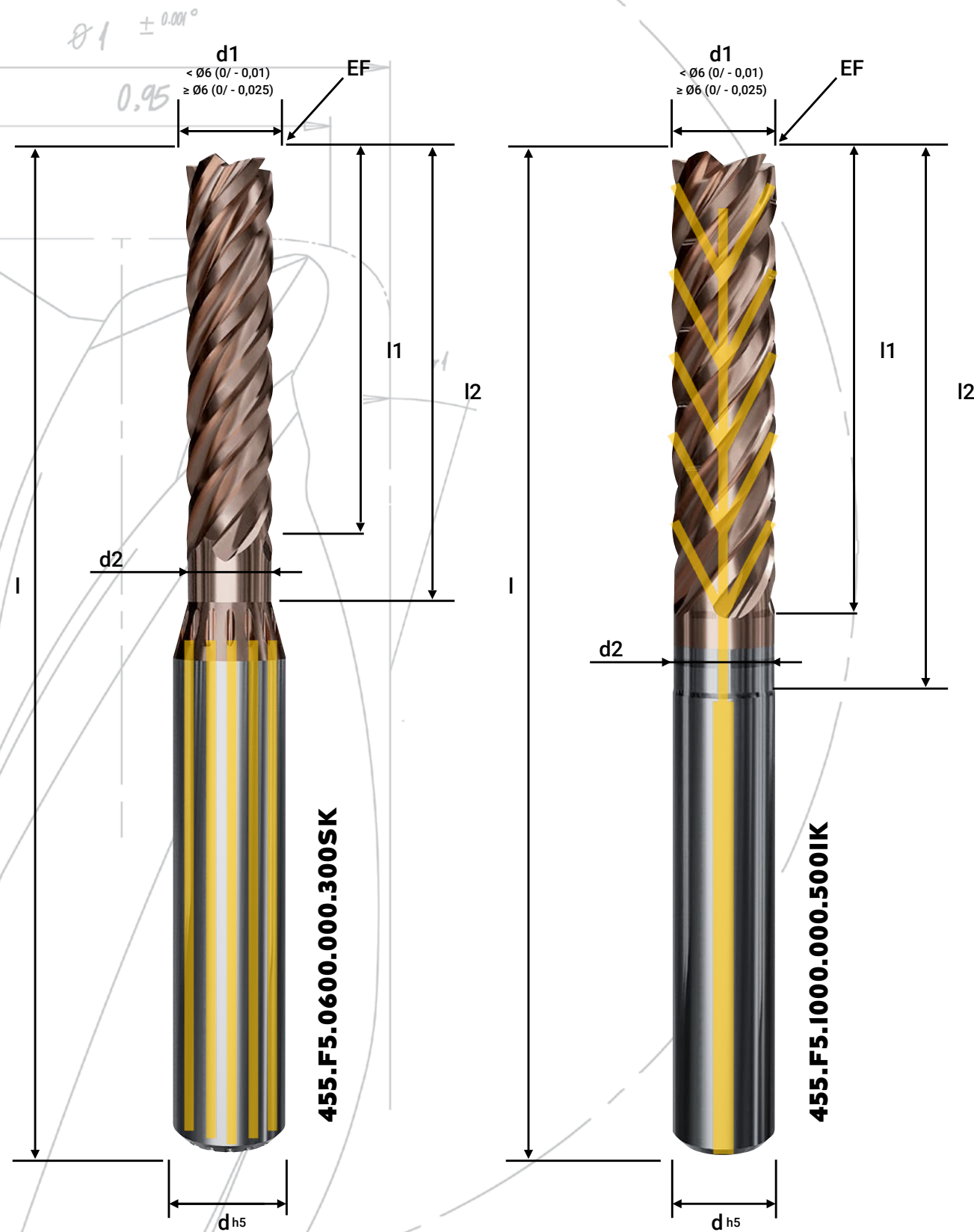

455.F5.0600.000.300SK

455.F5.1000.000.500IK

KINGFISHER 455.F5 SERIES

- Solid carbide 5-flute end mill with a 35° helix angle
- HPC (High Performace Cutting) optimized
- High-End WAD coating
- With shank coolant channels
- For dry or wet roughing/semi-finishing/finishing

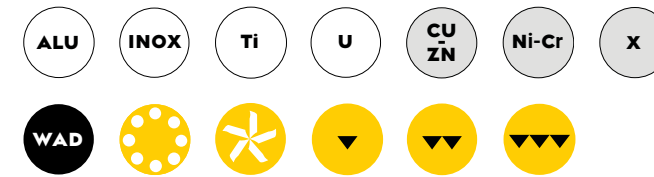

Article No.	d1	d2	EF	l1	l2	d	l	Z
455.F5.0600.000.240SK	6.0	5.90	0.1	18.0	24.0	8.0	68	5
455.F5.0600.000.300SK	6.0	5.90	0.1	24.0	30.0	8.0	68	5

- Solid carbide 5-flute end mill with a 35° helix angle
- HPC (High Performace Cutting) optimized
- High-End WAD coating
- With internal coolant channels
- For dry or wet roughing/semi-finishing/finishing

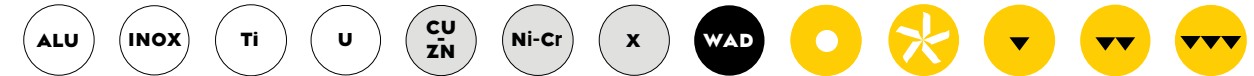

Article No.	d1	d2	EF	l1	l2	d	l	Z
455.F5.0800.000.320IK	8.0	7.9	0.1	24.0	32.0	8.0	68	5
455.F5.0800.000.400IK	8.0	7.9	0.1	32.0	40.0	8.0	80	5
455.F5.1000.000.350IK	10.0	9.8	0.2	30.0	35.0	10.0	80	5
455.F5.1000.000.500IK	10.0	9.8	0.2	40.0	50.0	10.0	95	5
455.F5.1200.000.450IK	12.0	11.8	0.2	36.0	45.0	12.0	93	5
455.F5.1200.000.520IK	12.0	11.8	0.2	48.0	52.0	12.0	100	5

KINGFISHER SERIES

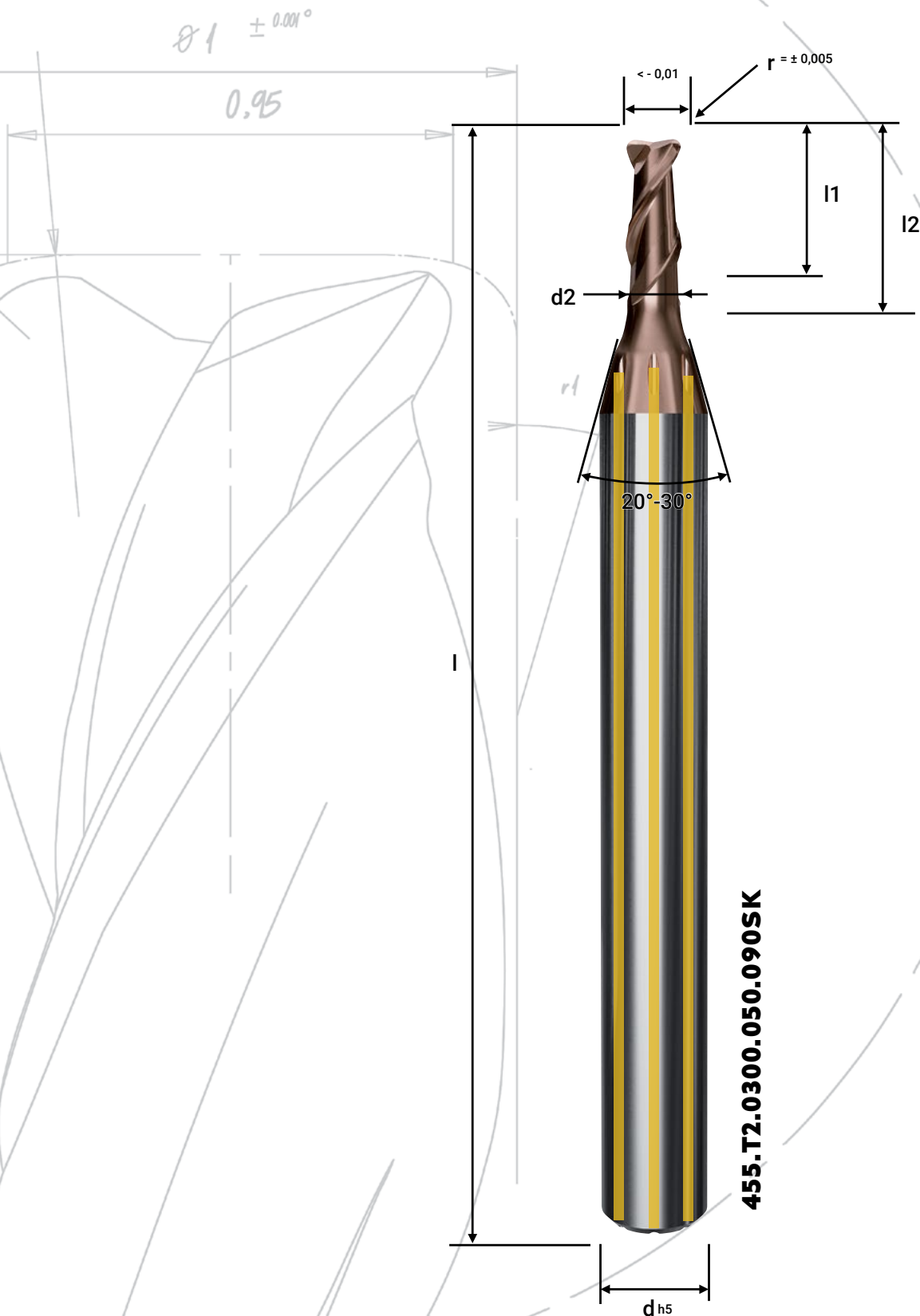

KINGFISHER 455.T2 SERIES

- Solid carbide 2-flute end mill with a corner radius and 40° helix angle
- HPC (High Performace Cutting) optimized
- High-End WAD coating
- With shank coolant channels
- For dry or wet roughing/semi-finishing/finishing

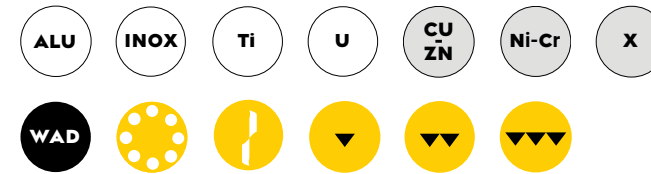

Article No.	d1	d2	r	l1	l2	d	l	Z
455.T2.0150.030.040SK	1.5	1.4	0.3	2.0	4.0	6.0	50	2
455.T2.0200.020.040SK	2.0	2.0	0.2	4.0	4.0	6.0	50	2
455.T2.0200.050.060SK	2.0	1.9	0.5	4.0	6.0	6.0	50	2
455.T2.0250.050.080SK	2.5	2.4	0.5	3.0	8.0	6.0	50	2
455.T2.0300.020.060SK	3.0	3.0	0.2	6.0	6.0	6.0	50	2
455.T2.0300.050.060SK	3.0	3.0	0.5	6.0	6.0	6.0	50	2
455.T2.0300.050.090SK	3.0	2.9	0.5	6.0	9.0	6.0	50	2
455.T2.0400.020.080SK	4.0	4.0	0.2	8.0	8.0	6.0	50	2
455.T2.0400.050.080SK	4.0	4.0	0.5	8.0	8.0	6.0	50	2

KINGFISHER SERIES

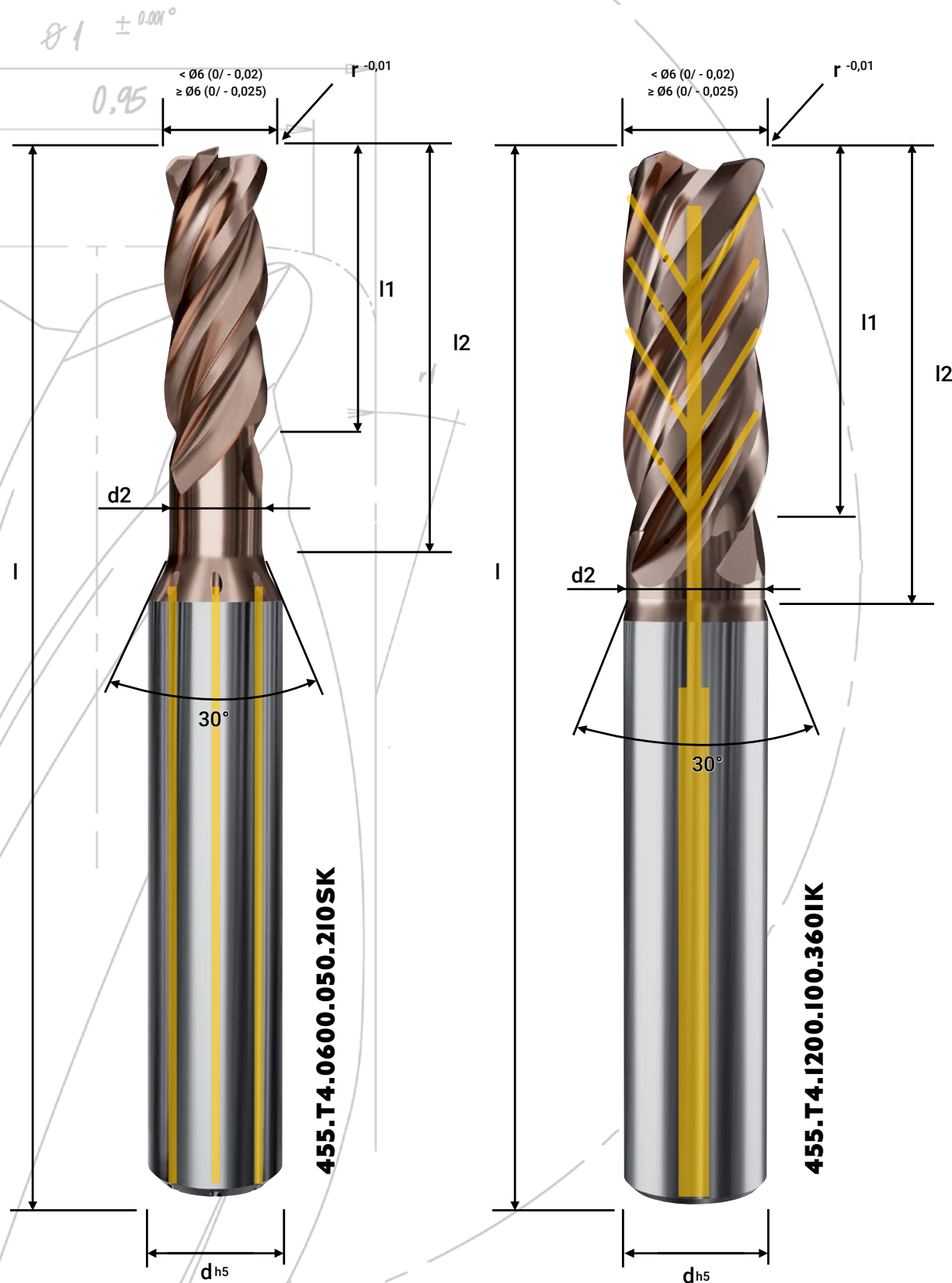

455.T4.0600.050.210SK

455.T4.1200.100.360IK

KINGFISHER 455.T4 SERIES

- Solid carbide 4-flute end mill with a corner radius and 35/37° helix angle
- HPC (High Performance Cutting) optimized
- High-End WAD coating
- With shank coolant channels
- For dry or wet roughing/semi-finishing/finishing

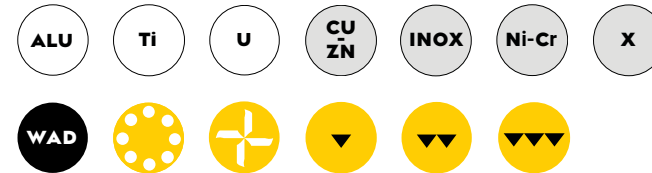

Article No.	d1	d2	r	l1	l2	d	l	Z
455.T4.0300.010.140SK	3.0	2.9	0.10	4.0	14.0	6.0	50	4
455.T4.0400.010.150SK	4.0	3.9	0.10	5.0	15.0	6.0	50	4
455.T4.0600.010.180SK	6.0	6.0	0.10	18.0	18.0	8.0	60	4
455.T4.0600.050.210SK	6.0	5.5	0.50	15.0	21.0	8.0	60	4
455.T4.0600.100.210SK	6.0	5.5	1.00	15.0	21.0	8.0	60	4

- Solid carbide 4-flute end mill with a corner radius and 35/37° helix angle
- HPC (High Performance Cutting) optimized
- High-End WAD coating
- With internal coolant channels
- For dry or wet roughing/semi-finishing/finishing

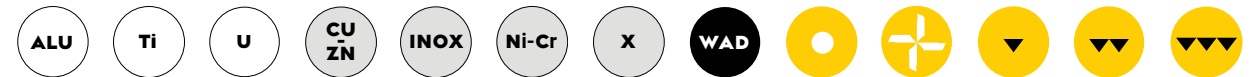

Article No.	d1	d2	r	l1	l2	d	l	Z
455.T4.0600.050.210IK	6.0	5.5	0.50	15.0	21.0	6.0	60	4
455.T4.0800.015.240IK	8.0	7.5	0.15	20.0	24.0	8.0	63	4
455.T4.0800.050.240IK	8.0	7.5	0.50	20.0	24.0	8.0	63	4
455.T4.1000.020.300IK	10.0	9.5	0.20	25.0	30.0	10.0	75	4
455.T4.1000.100.300IK	10.0	9.5	1.00	25.0	30.0	10.0	75	4
455.T4.1200.020.360IK	12.0	11.5	0.20	30.0	36.0	12.0	85	4
455.T4.1200.100.360IK	12.0	11.5	1.00	30.0	36.0	12.0	85	4

KINGFISHER SERIES

SERIES OVERVIEW

Some variations are available under the KINGFISHER SERIES which we break down below. Here you will find a brief explanation of the tool series as well as relevant symbols for the properties of the tools. More information about the series and a legend to the symbols can be found on the following pages.

Series	Suitable Materials							Suitable Machining Processes						Coating		Tool design						
	Copper	Aluminium	< 1.000 N/mm ² Steel	> 1.000 N/mm ² Steel	Stainless steel	Nickel-Chrome	Titanium	Brass	Roughing	Semi-finishing	Finishing	HSC	HPC	Dry	Wet	BCR	WAD	Geometry	Flutes	Shank cooling	Internal cooling	Measurement protocol
455	xx	xx					xx	xx	x	x	x	x		x	x			Ball	3			
455M			x		xx	x	xx	x	x	x	x			x	x	x		Ball	3			
455P		x	xx	x	xx	x	xx	x	x	x	x			x	x		x	Ball	3			
455S.B3SK		xx	xx	x	x	x	xx	x	x	x	x			x	x		x	Ball	3	x		
455S.B3IK		xx	xx	x	x	x	xx	x	x	x	x			x	x		x	Ball	3		x	
455.F3		xx	xx	x	x	x	xx	x	x	x		x		x	x		x	Square	3	x		
455.F5SK		xx	xx	x	xx	x	xx	x	x	x		x		x	x		x	Square	5	x		
455.F5IK		xx	xx	x	xx	x	xx	x	x	x		x		x	x		x	Square	5			x
455.T2		xx	xx	x	xx	x	xx	x	x	x		x		x	x		x	Toric	2	x		
455.T4SK		xx	xx	x	x	x	xx	x	x	x		x		x	x		x	Toric	4	x		
455.T4IK		xx	xx	x	x	x	xx	x	x	x		x		x	x		x	Toric	4			x

¹ „xx“ indicates that it is optimally designed for processing this material, „x“ indicates that it also works in this material.

KINGFISHER SERIES

ICON LEGEND

- White background icons represent Primary Recommended Materials
- Grey background icons represent Secondary Recommended Materials
- Icons to represent the tool design properties
- Icons to represent the tool design properties
- Icons to represent the indication types of the tool

ICONS APPEARING IN THIS FLYER

Material

ALU ALUMINIUM	CU COPPER	CU-ZN BRASS	INOX STAINLESS STEEL
Ni-Cr	Ti TITANIUM	U < 1.000 N/MM ² STEEL	X > 1.000 N/MM ²

Coating

WAD WAD COATING	BCR BCR COATING
---------------------------	---------------------------

Tool properties

2-FLUTES	3-FLUTES	4-FLUTES	5-FLUTES	INTERNAL COOLANT CHANNELS	SHANK COOLANT CHANNELS
-----------------	-----------------	-----------------	-----------------	----------------------------------	-------------------------------

Recommended use

ROUGHING	PRE-FINISHING	FINISHING
-----------------	----------------------	------------------

FURTHER INFO

1. No negative impact from the cooling channels during clamping. Also suitable for shrink fitting.
2. No reduction in the core stability within the tool's active area.
3. Ball end mills with 100% center cutting and 3 flutes are excellent for flat surfaces.
4. End mills are ideally designed for trochoidal machining. Also available as a custom tool with chip breakers.

AWARD-WINNING: AWARDS FOR OUTSTANDING PERFORMANCE

Only with motivated, positive thinking and independent personalities can a company exist and grow together on new challenges. ZECHA is proud of all its employees for their tireless commitment, passion for progress and willingness to actively contribute to innovation. The awards are the result of creative collaboration and a tribute to the industry.



INNOVATION AWARD OF THE STATE OF BADEN-WÜRTTEMBERG

In 2021, ZECHA Hartmetall-Werkzeugfabrikation GmbH was awarded the Innovation Prize of the State of Baden-Württemberg for the first time. The prize was awarded for the development of a tool family with diamond-coated micro-precision tools that offer outstanding performance in machining the most demanding materials with smooth surfaces. These achievements set new standards worldwide in the field of precision tools.



TOP 100-AWARD

With its outstanding innovation management, ZECHA Hartmetall-Werkzeugfabrikation GmbH receives the TOP 100 seal 2023, an award that is only given to particularly innovative medium-sized companies. The competition is based on a scientific selection process. The decisive factor is whether a company's innovations are random or systematically planned and will be repeatable in the future.

KINGFISHER
SERIES

$\varnothing 1 \pm 0.001^{\circ}$

0.95



THE NEW ZECHA BRANDING

Over the years, brands consistently evolve and transform to meet the changing needs and preferences of their consumers. In the competitive landscape of 2024, ZECHA is poised to introduce its new brand identity, marking a significant milestone in its journey. The unveiling of the ZECHA branding represents a culmination of the brand's growth and commitment to excellence.

At the core of the new ZECHA logo lies a perfect circle, which symbolizes the meticulous process of the first step in the process of making all tools at ZECHA which is grinding tools into flawless cylinders. This iconic image embodies ZECHA's

dedication to precision and quality. It signifies the brand's unwavering pursuit of perfection, ensuring that every tool manufactured by ZECHA is perfectly concentric, guaranteeing superior performance.

In the new branding, ZECHA also integrates the word "außergewöhnlich" into various visuals. Derived from the German language, "außergewöhnlich" translates to "extraordinary" in English. This carefully chosen word encapsulates the overarching goal of every product created by ZECHA. It signifies the brand's commitment to delivering exceptional tools that surpass

The ZECHA Logo through the years:



TOP
100

top100.de

Top-Innovator
2023

ZECHA'S COMMITMENT TO EXCELLENCE

OVER HALF A CENTURY OF PRECISION

ZECHA Hartmetall-Werkzeugfabrikation GmbH is a precision tool manufacturer that has been in BadenWürttemberg, Germany for 60 years. With a focus on manufacturing high quality micro tools, we pride ourselves on providing our customers with the highest level of precision and consistency in our products. Our state-of-the-art manufacturing and measurement technologies allow us to maintain the highest quality standards and ensure that our tools meet our customers' needs.

With a focus on innovation and the constant research of new technologies, we improve the precision and efficiency of our tools. This philosophy allows us to stay at the forefront of the industry and provide our customers with state-of-the-art solutions for their tooling needs.

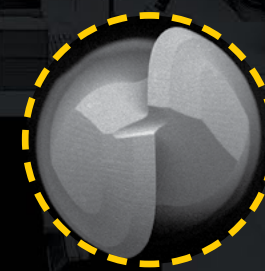

$81 \pm 0.001^\circ$

0.95



ZECHA
außergewöhnlich.

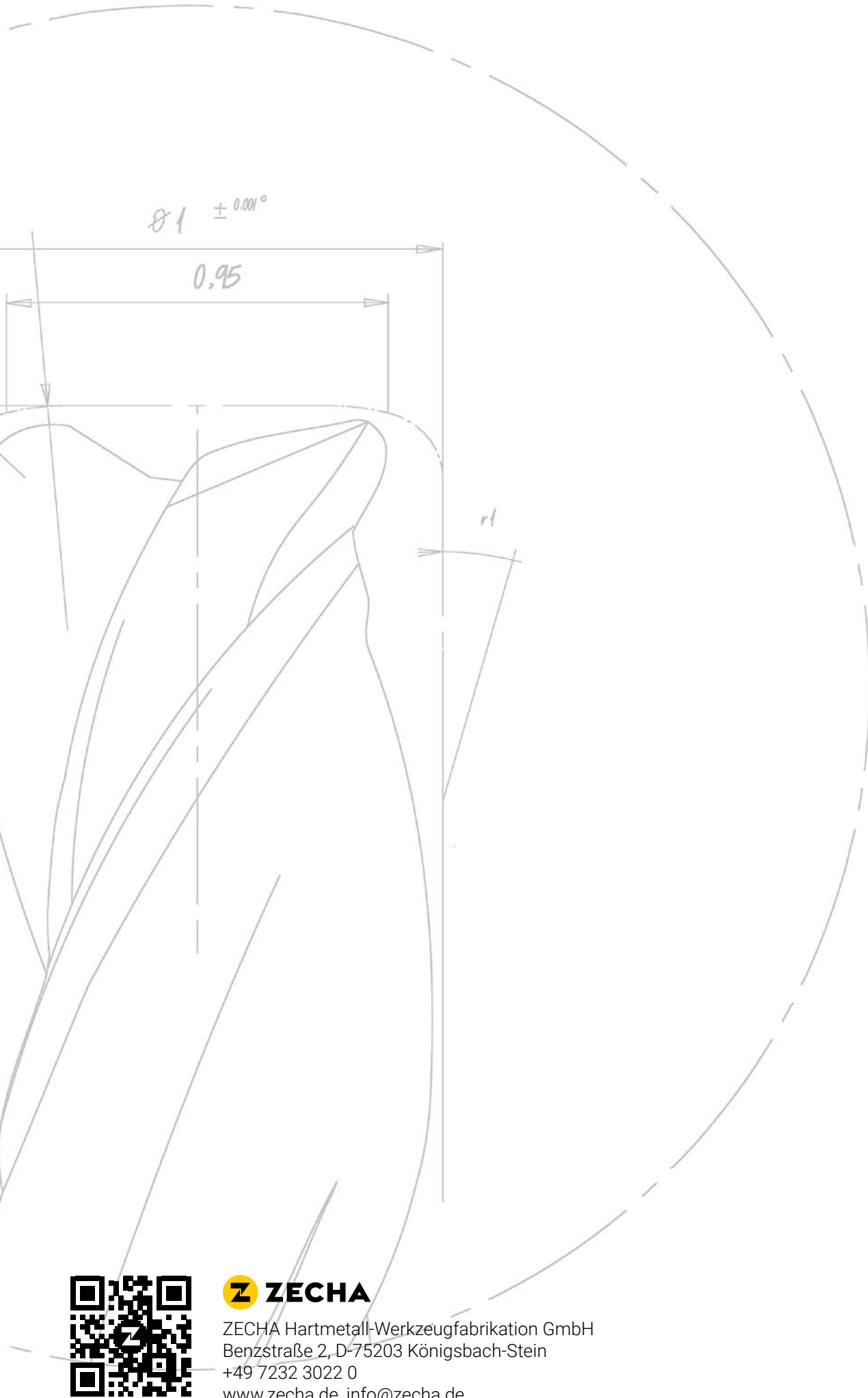

Z ZECHA

ZECHA Hartmetall-Werkzeugfabrikation GmbH
Benzstraße 2, D-75203 Königsbach-Stein
+49 7232 3022 0
www.zecha.de, info@zecha.de

